

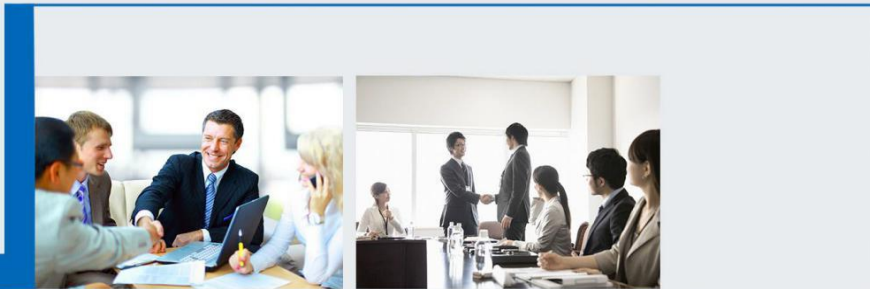

Htek IP Phones UC9xx Series User Manual



**Version 2.42.6.5
2023.5**

Copyright

Copyright © 2023 Nanjing Hanlong Technology CO., LTD. All rights reserved.

Nanjing Hanlong Technology Co., LTD. owns all the rights to modify and copy this document at any time. And all the illustrations and text in this document are copyright protected. Therefore, no parts of this document may be used or reproduced, transmitted by the third parties for any purposes without the express written permission of Nanjing Hanlong Technology CO., LTD.

When this document is made available on www.htek.com, Nanjing Hanlong Technology Co., LTD. gives its right to download and print copies of this content only for private use as a user manual. No parts shall have the right to alter, modify or use as commercial means without prior written permission from Nanjing Hanlong Technology Co., LTD.

Safety Instructions

- To use the Phone, please follow the instructions in this user manual.
- Use the power adapter supplied with your phone. Other power adapters may damage the phone.
- This phone is only for indoor use. And also avoid in high humidity, water and some other liquids.
- Do not use the phone during thunderstorms.
- CE
- FCC

WEEE Warning



To avoid the potential effects on the environment and human health as a result of the presence of hazardous substances in electrical and electronic equipment, end users of electrical and electronic equipment should understand the meaning of the crossed-out wheeled bin symbol. Do not dispose of WEEE as unsorted municipal waste and have to collect such WEEE separately.

Cleaning

To clean the device, use an anti-static cloth. Please avoid cleaning liquids as they might damage the surface or internal electronics of the phone.

FCC Statement

This device complies with Part 15 of the FCC Rules. Operation is subject to the following two conditions: (1) This device may not cause harmful interference, and (2) this device must accept any interference received, including interference that may cause undesired operation.

WARNING: Any changes or modifications not expressly approved by the party responsible for

compliance could void the user's authority to operate this equipment.

NOTE: This equipment has been tested and found to comply with the limits for a Class B digital device, pursuant to Part 15 of the FCC Rules. These limits are designed to provide reasonable protection against harmful interference in a residential installation.

This equipment generates uses and can radiate radio frequency energy and, if not installed and used in accordance with the instructions, may cause harmful interference to radio communications.

However, there is no guarantee that interference will not occur in a particular installation. If this equipment does cause harmful interference to radio or television reception, which can be determined by turning the equipment off and on, the user is encouraged to try to correct the interference by one or more of the following measures:

- Reorient or relocate the receiving antenna.
- Increase the separation between the equipment and receiver.
- Connect the equipment into an outlet on a circuit different from that to which the receiver is connected.
- Consult the dealer or an experienced radio/TV technician for help.

*RF warning for Mobile device:

This equipment complies with FCC radiation exposure limits set forth for an uncontrolled environment. This equipment should be installed and operated with minimum distance 20cm between the radiator & your body.

Table of Content

Notices Information.....	2
Copyright	2
Safety Instructions.....	2
WEEE Warning.....	2
Cleaning.....	2
FCC Statement.....	2
Table of Content.....	4
Before You Begin	9
Getting Started.....	10
Packing List	10
UC9XX Packing List.....	10
Phone Installation	12
UC9xxPhone Installation.....	12
Hardware Components Preview.....	13
UC926(U/S/E).....	13
UC924(U/S/W/E).....	14
UC923(U/E).....	14
UC921(U/E/G/P).....	18
UC912(E/G/P).....	21
UC902(P).....	21
UC903.....	24
UC902S(P)/UC902E/UC902G.....	27
Idle Screen.....	30
UC926(U/S/E).....	30
UC924(U/S/W).....	30
UC923(U/E).....	31
UC921(U/E/G/P).....	31
UC912(E/G/P)/UC903.....	32
UC902(S/P/E/SP/G).....	33
Initialization Process.....	34
Status.....	34
Registration.....	37
Getting Familiar with Your Phone	40
Icon Preview	40
LED Instruction	43
Power Indicator LED	43
Line LED (Line Key set as Line).....	43
BLF or BLF List Key LED (Line/Line Key set as BLF).....	43
Shared Line LED	44
User Interface	44
Call Features.....	45
Basic Call Features	46
Place a Call	46
End a Call	47
Redial a Call	47
Receive a Call	47
Incoming Call Show Mode	48
Auto Answer	48
Call Hold/Resume	48
Call Transfer	49
Call Conference.....	51

Call Forward	52
Call Return.....	55
Call Waiting Tone.....	56
Hide Caller ID	56
Reject Anonymous	57
Call Mute	57
DND	57
Hot Line	58
Auto Redial	59
Help center	60
Diagnostics	62
Power Saving	64
Advanced Call Features	65
Call Pickup.....	65
Group Pickup.....	66
Call Park	66
Busy Lamp Field (BLF).....	67
Visual Alert for BLF Pickup.....	67
Audio Alert for BLF Pickup	68
BLF List	69
Share Line	69
Intercom.....	70
Intercom Barge	71
Short Message Service (SMS).....	71
Voice Mail	72
Using the Hot Desking.....	74
Automatic Call Distribution (ACD)	75
Directory.....	76
Local Directory.....	76
Contact Groups	76
Managing the Local Directory Contacts	77
Moving a Local Directory Contact to Blacklist.....	80
Searching for Contacts.....	80
Upload Contacts photo.....	80
To import or export the contact list	82
Blacklist.....	83
Adding a Blacklist Contact	83
Viewing Blacklist Contacts	84
Editing a Blacklist Contact.....	84
Deleting Blacklist Contacts.....	84
Moving a Blacklist Contact to the Local Directory.....	84
Remote Phonebook.....	85
LDAP Phonebook	86
Call History Setting	88
Call History	88
Audio Settings.....	92
Ring Tone.....	92
Volume	94
Voice Mail Tone.....	95
Play Hold Tone.....	95
Play Hold Tone Delay	96
Voice	96
Handfree AGC	96
Volume Amplification	97
Handset Send Volume.....	97
Headset Send Volume.....	97
Handfree Send Volume	98
Extra Loud	98
USB.....	100
USB Recording.....	100

Manage your recordings	101
USB Headset	102
Adding a Wallpaper from a USB Flash Drive	103
Adding a Screen Saver from a USB Flash Driver	104
Bluetooth	105
How to Activate Bluetooth?	105
To activate Bluetooth via Phone interface:	105
How to Pair the Bluetooth Headset to the Phone?	106
Open the Bluetooth pairing mode on Bluetooth headset:	106
How to scan the Bluetooth headset device on phone interface:	106
How to edit device information?	108
How to edit device information on phone interface:	108
How to answer an incoming call?	109
How to adjust the earphone volume during a call?	109
How to End Call?	110
Wi-Fi	110
How to Enable Wi-Fi feature?	110
How to Connect the UC926U to an Available Wireless Network?	111
How to view Wireless Network status?	113
How to Disconnect Wireless Network?	114
How to Manually Add a Wireless Network?	114
How to Disable Wi-Fi feature?	115
Function Key	115
Line Keys	116
Line	116
Speed Dial	117
BLF	117
DTMF	118
Prefix	118
Local Group	119
XML Group	119
XML Browser	120
Network Directories	120
Conference	121
Forward	122
Transfer	122
Hold	123
DND	123
Redial	124
Record	124
URL Record	125
Paging	126
Group Listening	126
Public Hold	127
Private Hold	127
Zero Touch	128
Multicast Paging	129
Programmable Key	132
Customizing the Soft Keys	132
Customizing the hard Keys	133
Exp Key	133
Customizing Your Phone	134
Administrator Password	134
Language	135
Wallpaper	136
Screen Saver	138
Backlight	140
Time and Date	140
LED Status Setting	143
Key as Send	144

Dial Plan.....	145
Phone Lock.....	146
Emergency Call.....	147
Action URL.....	148
Softkey Layout.....	149
Settings.....	150
General settings.....	150
Dial-Now Timeout.....	150
No Key Entry Timeout.....	151
Label Scroll.....	151
Show Missed Calls.....	151
Auto Logout Time.....	152
Reboot in Talking.....	152
Detect IP Conflict.....	153
Redial Mode.....	153
Suppress DTMF Display.....	153
Suppress DTMF Display Delay.....	153
Check-Syn With Authenticate.....	153
Headset Mode.....	154
Linekey Page Reset.....	155
Gray Level.....	155
Network settings.....	156
IPv4.....	156
IPv6.....	158
IPv4&IPv6.....	160
Preference (IPv4/IPv6).....	161
PC Port.....	161
System settings.....	162
Factory Reset.....	162
Pcap Feature.....	162
System Log.....	163
Upgrade.....	163
Configuration File.....	165
Optional Accessories with Your Phone.....	166
Headsets.....	166
Bluetooth Headset.....	166
Using Headsets.....	166
Expansion module.....	167
Connecting the Expansion Module.....	167
USB Button.....	168
Troubleshooting.....	169
Why is the phone LCD screen blank?.....	169
Why does the phone display “Network Unavailable”?.....	169
Why can't I get a dial tone?.....	169
Where to set the tone?.....	169
How to download XML Configuration?.....	170
How to Import Trusted CA certificate?.....	170
How to Import Server CA certificate?.....	171
How to use Vlan?.....	172
How to use LLDP?.....	172
How to Set LCD and Web GUI?.....	172
How to Upgrade via FTP?.....	172
How to make Ringtone?.....	173
How to use Open VPN?.....	173
Provisioning Guide on Free PBX.....	173
Redundancy Server.....	173
How to Use Auto Provision Phonebook?.....	173
All Documents.....	173

Revision History

Version Number	Revision Date	Revision Description
V2.42.6.5	2022.9.28	1. Add Gray Level 2. Update LED Instruction 3. Add Zero Touch function 4. Add Linekey Page Reset function
V2.42.6.5	2023.5.26	1. Add USB button function

Before You Begin

This guide provides information you need to quickly use your new phone.

Firstly, verify with your system administrator that the IP network is ready for phone configuration. Also, be sure to read the Quick Start Guide which can be found in your phone package before you set up and use the phone. As you read this guide, keep in mind that some features are only configurable by your system administrator or determined by your phone environment. As a result, some features may not be enabled or may be operated differently on your phone. Additionally, the examples and graphics in this guide may not directly reflect what is displayed or is available on your phone screen.

Note: This guide mainly takes UC926U IP phones as an example.

This user guide contains information for the following HTEK products:

- UC926(U)(S)(E) Enterprise HD IP Phones
- UC924(U)(W)(E) Enterprise HD IP Phones
- UC923(U) Enterprise HD IP Phones
- UC921(U)(E)(G)(P) Enterprise HD IP Phones
- UC912(E)(G)(P) Enterprise HD IP Phones
- UC902P HD Entry Level Phones
- UC902S(SP) HD Entry Level Phones
- UC902E HD Entry Level Wi-Fi Phones
- UC902G HD Entry Level Phones

Getting Started

Packing List

UC9XX Packing List

The package contains the following parts, please check if all the items are not missed:

1. The phone station

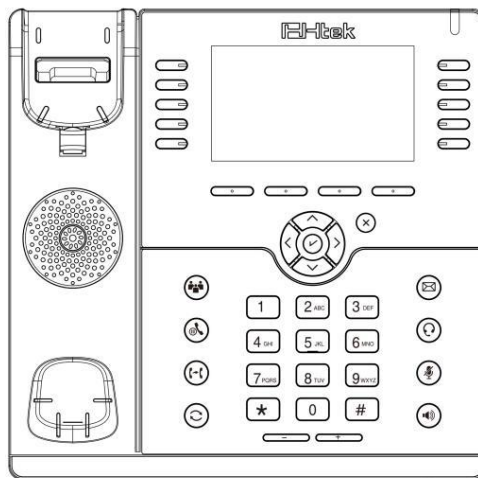

2. The phone stand

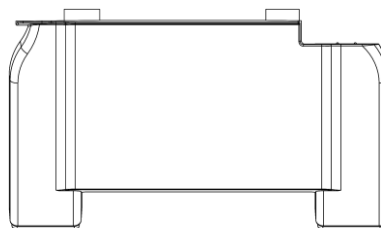

3. Handset

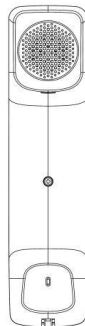

4. Handset cord

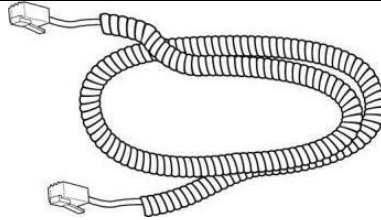

5. Power adapter

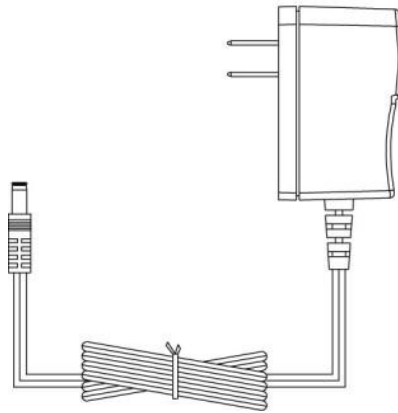

6. Ethernet cable

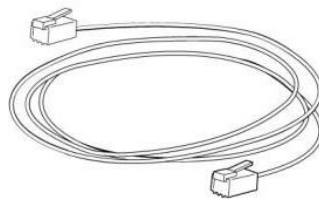

7. Quick installation reference



Phone Installation

UC9xxPhone Installation

1. Attach the phone stand

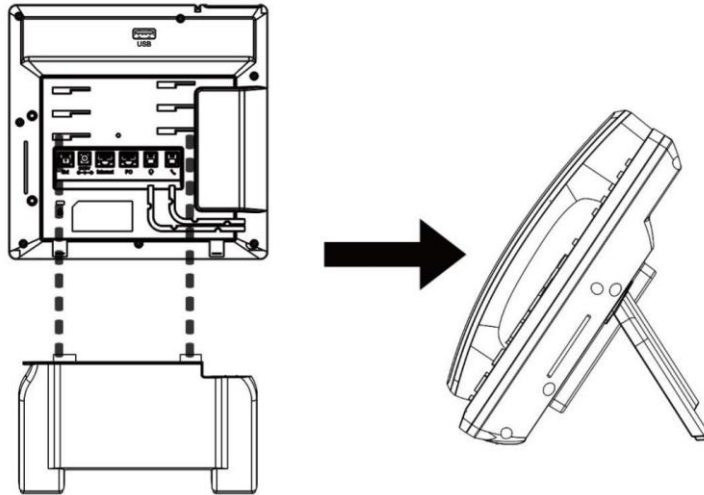

2. Connect the Handset and optional Headset

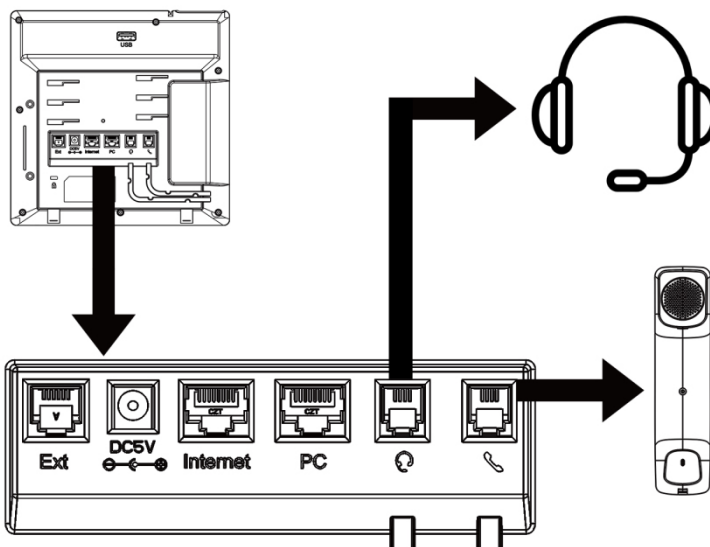

3. Connect the Network and Power

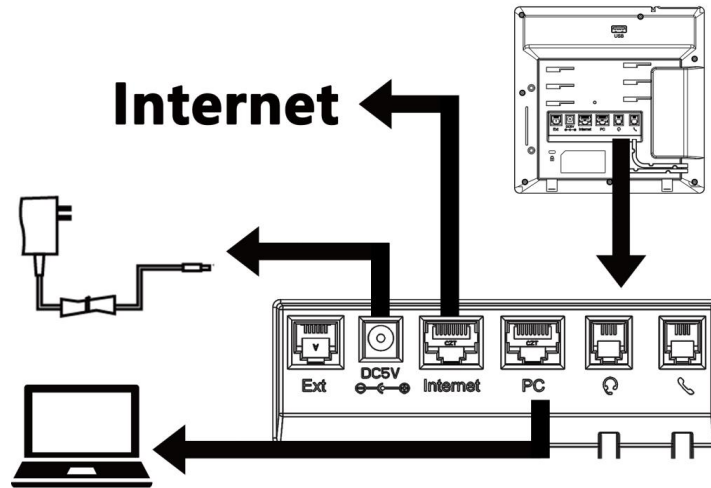

Hardware Components Preview

UC926(U/S/E)

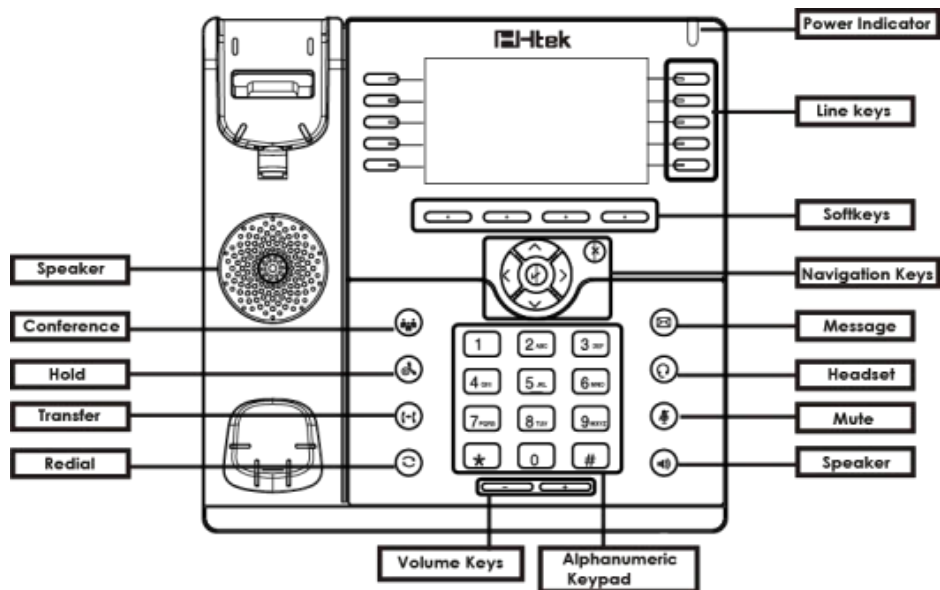

UC924(U/S/W/E)

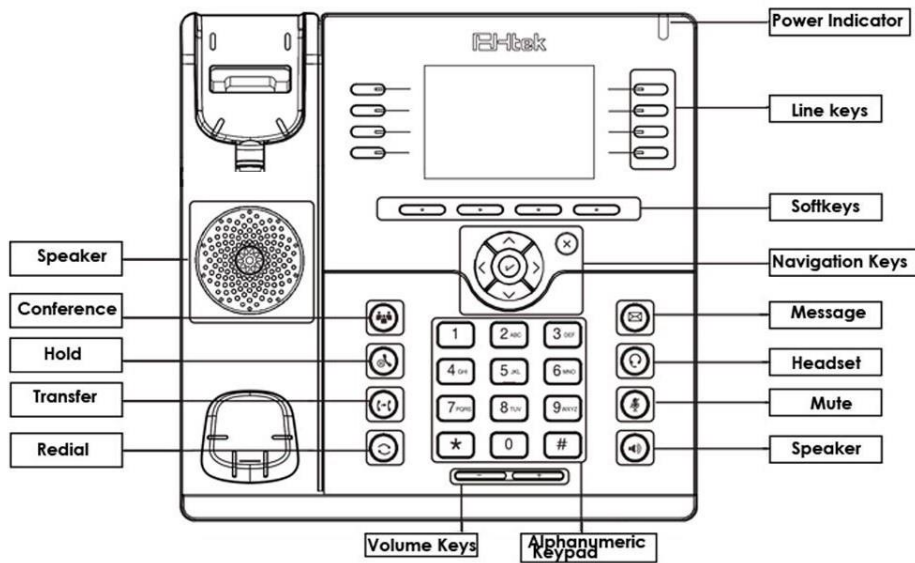

UC923(U/E)

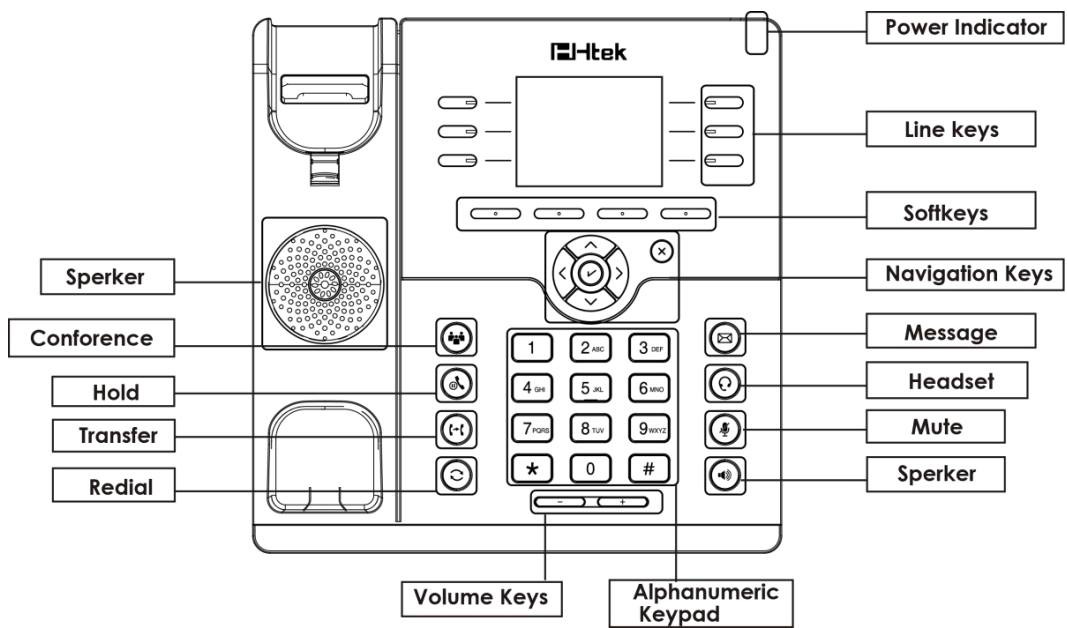

Item	Description
LCD screen	To Presentation all information about the date& time, accounts, soft keys, messages, calls and other some information.
Power Indicator LED	To indicate the power status
Line keys	<p>The phone supported up to 16 accounts on UC926(U/S/E)</p> <p>The phone supported up to 12 accounts on UC924(U/S/W/E)</p> <p>The phone supported up to 8 accounts on UC923(U)</p> <p>Steady green: idle interface, during a call..</p> <p>Blink red: a call incoming</p>
Soft keys	Labels automatically to identity their context-sensitive features.
Navigation keys	<p>Navigation Keys</p> <ol style="list-style-type: none"> 1. Scroll the information or options displayed on the screen. 2. You can quickly access historical records and directories. <p>OK key</p> <ol style="list-style-type: none"> 1. Can quickly enter the menu 2. Save the configuration 3. Answer the call <p>Cancel key</p> <ol style="list-style-type: none"> 1. Cancel actions 2. Reject the call 3. To return to idle screen. <p>Up arrow key: To move up of the selection shows on the screen.</p> <p>Right arrow key: To move right of the selection shows on the screen.</p> <p>Left arrow key: To move left of the selection shows on the screen.</p> <p>Down arrow key: To move down of the selection shows on the screen.</p>
Mute key	<ol style="list-style-type: none"> 1. To mute the voice during the call (Red light). 2. To un-mute the call.
Conference	To place a conference call

Line Keys	To be configured as different function as: Line Speed Dial BLF BLF List Voice Mail Direct Pickup Group Pickup Call Park Intercom DTMF Prefix Local Group XML Group XML Browser LDAP Network Directories Conference Forward Transfer Hold DND Redial Call Return SMS Record URL Record Group Listening Public Hold Private Hold Hot Desking ACD
-----------	---

	<p>Zero Touch</p> <p>URL</p> <p>Network Group</p> <p>Multicast Paging</p> <p>Group Call Park</p> <p>Call Park Retrieve</p> <p>XML BLF</p> <p>Silent Call</p> <p>Smart BLF</p>
Speaker	Press this button to place a call in hands-free mode.
Redial	<p>To dial the previous dialed number.</p> <p>To act as send key.</p>
Volume	<p>To decrease the volume.</p> <p>To increase the volume.</p>
Hold	To hold or to resume a call during a conversation.
Headset	To indicate that the phone is or not in Headset mode.
Transfer	<p>To transfer a call to a third party.</p> <p>To enable or disable Forward feature during the idle page.</p>
Alphanumeric keypad	To enter the phone numbers, letters and so on.
Message	To indicator the New message, and press to read.

UC921(U/E/G/P)

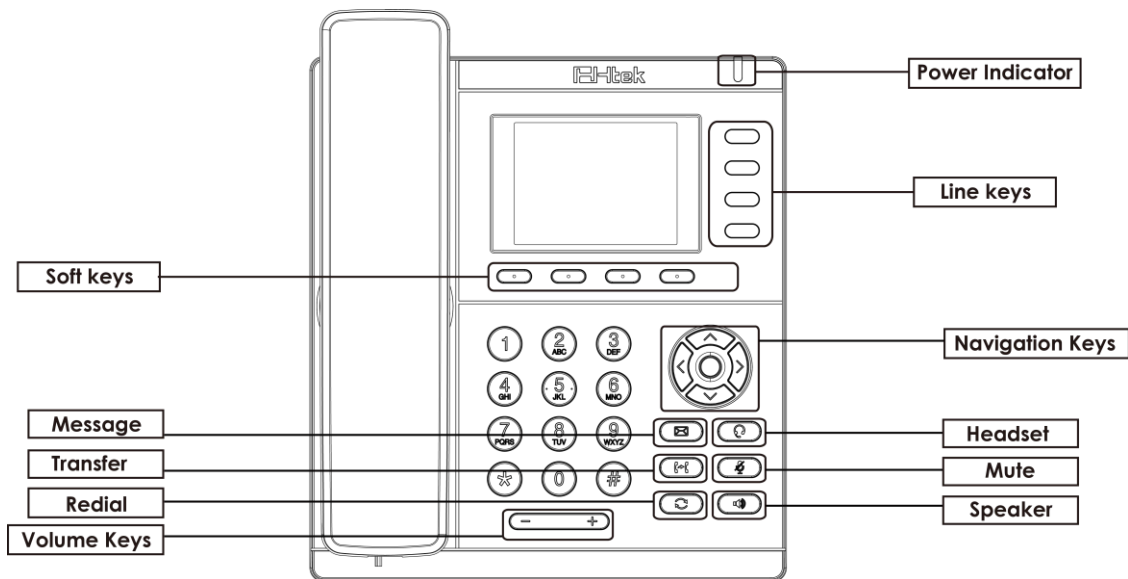

Item	Description
LCD screen	To Presentation all information about the date& time, accounts, soft keys, messages, calls and other some information.
Power Indicator LED	To indicate the power status
Line keys	The phone supported up to 4 accounts Steady green: idle interface, during a call.. Blink red: a call incoming
Soft keys	Labels automatically to identify their context-sensitive features.
Navigation keys	<p>Navigation Keys</p> <ol style="list-style-type: none"> 1. Scroll the information or options displayed on the screen. 2. You can quickly access historical records and directories. <p>OK key</p> <ol style="list-style-type: none"> 1. Can quickly enter the menu 2. Save the configuration 3. Answer the call <p>Up arrow key: To move up of the selection shows on the screen.</p> <p>Right arrow key: To move right of the selection shows on the screen.</p> <p>Left arrow key: To move left of the selection shows on the screen.</p> <p>Down arrow key: To move down of the selection shows on the screen.</p>

Mute key	<ol style="list-style-type: none">1. To mute the voice during the call (Red light).2. To un-mute the call.
Line Keys	<p>To be configured as different function as:</p> <ul style="list-style-type: none">LineSpeed DialBLFBLF ListVoice MailDirect PickupGroup PickupCall ParkIntercomDTMFPrefixLocal GroupXML GroupXML BrowserLDAPNetwork DirectoriesConferenceForwardTransferHoldDNDRedialCall ReturnSMSRecordURL RecordGroup ListeningPublic HoldPrivate HoldHot DeskingACD

	<p>Zero Touch</p> <p>URL</p> <p>Network Group</p> <p>Multicast Paging</p> <p>Group Call Park</p> <p>Call Park Retrieve</p> <p>XML BLF</p> <p>Silent Call</p> <p>Smart BLF</p>
Speaker	Press this button to place a call in hands-free mode.
Redial	<p>To dial the previous dialed number.</p> <p>To act as send key.</p>
Volume	<p>To decrease the volume.</p> <p>To increase the volume.</p>
Transfer	<p>To transfer a call to a third party.</p> <p>To enable or disable Forward feature during the idle page.</p>
Alphanumeric keypad	To enter the phone numbers, letters and so on.
Message	To indicator the New message, and press to read.
Headset	To indicate that the phone is or not in Headset mode.

UC912(E/G/P)

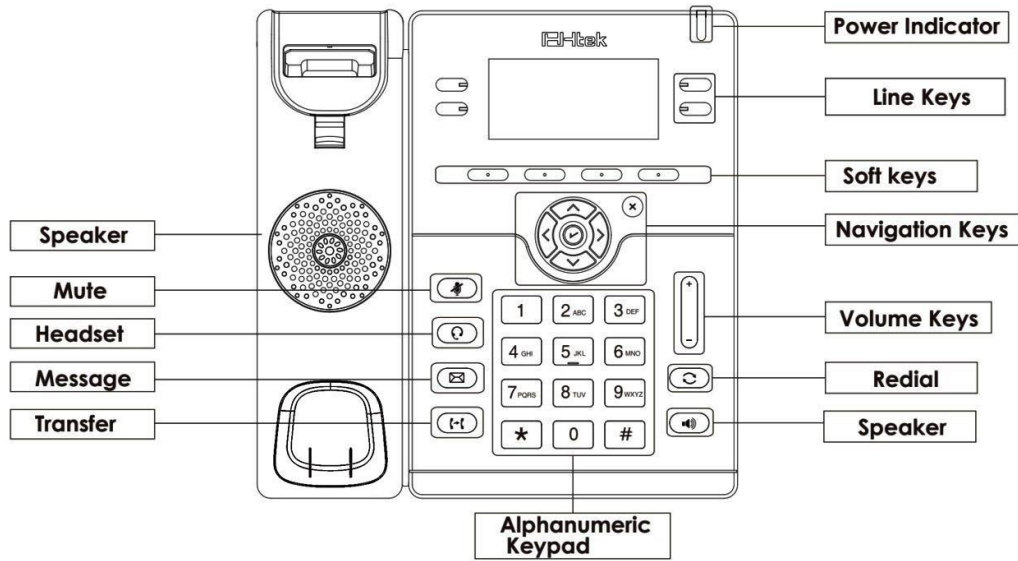

UC902(P)

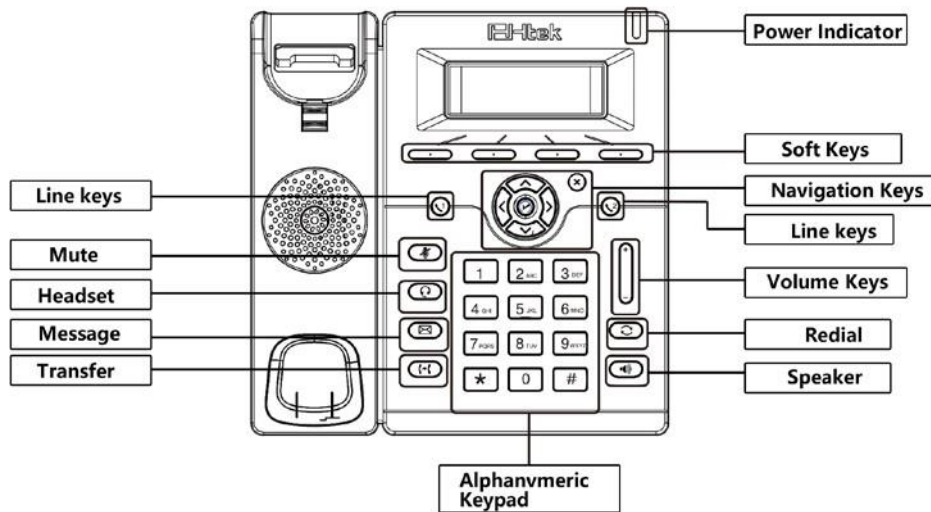

Item	Description
LCD screen	To Presentation all information about the date& time, accounts, soft keys, messages, calls and other some information.
Power Indicator LED	To indicate the power status
Line keys	The phone supported up to 4 accounts on UC912(E/G/P) The phone supported up to 2 accounts on UC902(P) Steady green: idle interface, during a call.. Blink red: a call incoming

Soft keys	Labels automatically to identify their context-sensitive features.
Navigation keys	<p>Navigation Keys</p> <ol style="list-style-type: none"> 1. Scroll the information or options displayed on the screen. 2. You can quickly access historical records and directories. <p>OK key</p> <ol style="list-style-type: none"> 1. Can quickly enter the menu 2. Save the configuration 3. Answer the call <p>Cancel key</p> <ol style="list-style-type: none"> 1. Cancel actions 2. Reject the call 3. To return to idle screen. <p>Up arrow key: To move up of the selection shows on the screen.</p> <p>Right arrow key: To move right of the selection shows on the screen.</p> <p>Left arrow key: To move left of the selection shows on the screen.</p> <p>Down arrow key: To move down of the selection shows on the screen.</p>
Mute key	<ol style="list-style-type: none"> 1. To mute the voice during the call (Red light). 2. To un-mute the call.
Line Keys	<p>To be configured as different function as:</p> <ul style="list-style-type: none"> Line Speed Dial BLF BLF List Voice Mail Direct Pickup Group Pickup Call Park Intercom DTMF Prefix Local Group XML Group XML Browser LDAP Network Directories Conference

	<p>Forward</p> <p>Transfer</p> <p>Hold</p> <p>DND</p> <p>Redial</p> <p>Call Return</p> <p>SMS</p> <p>Record</p> <p>URL Record</p> <p>Group Listening</p> <p>Public Hold</p> <p>Private Hold</p> <p>Hot Desking</p> <p>ACD</p> <p>Zero Touch</p> <p>URL</p> <p>Network Group</p> <p>Multicast Paging</p> <p>Group Call Park</p> <p>Call Park Retrieve</p> <p>XML BLF</p> <p>Silent Call</p> <p>Smart BLF</p>
--	---

Speaker	Press this button to place a call in hands-free mode.
Redial	<p>To dial the previous dialed number.</p> <p>To act as send key.</p>
Volume	<p>To decrease the volume.</p> <p>To increase the volume.</p>
Transfer	<p>To transfer a call to a third party.</p> <p>To enable or disable Forward feature during the idle page.</p>
Alphanumeric keypad	To enter the phone numbers, letters and so on.
Message	To indicator the New message, and press to read.
Headset	To indicate that the phone is or not in Headset mode.

UC903

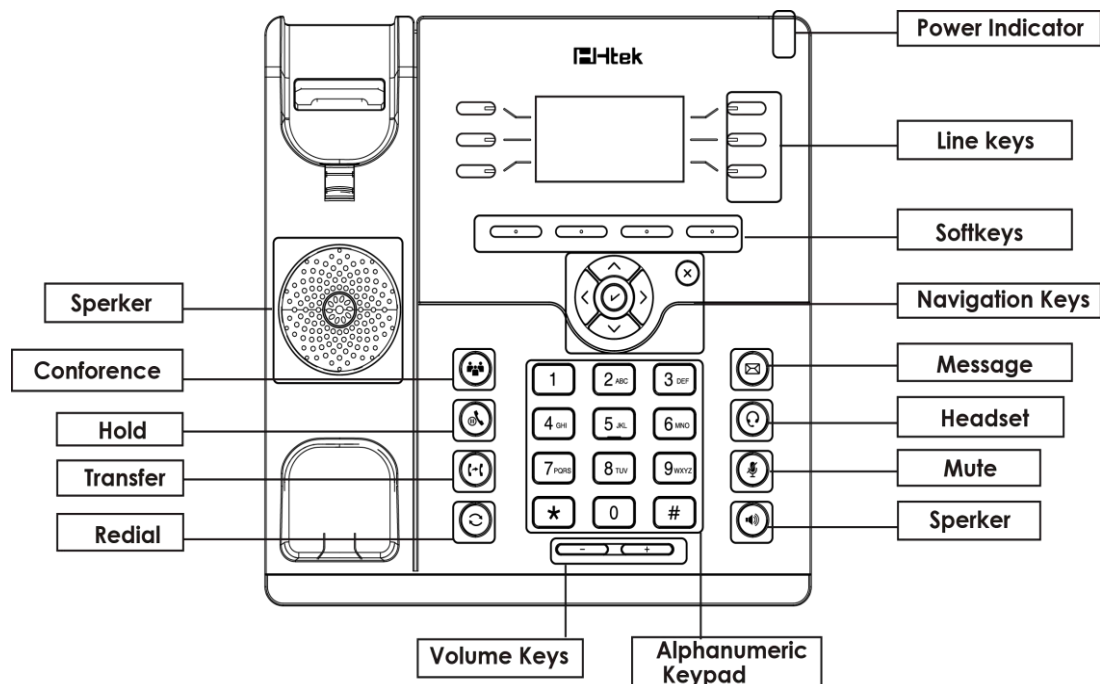

Item	Description
LCD screen	To Presentation all information about the date& time, accounts, soft keys, messages, calls and other some information.
Power Indicator LED	To indicate the power status
Line keys	The phone supported up to 4 accounts Steady green: idle interface, during a call.. Blink red: a call incoming
Soft keys	Labels automatically to identify their context-sensitive features.
Navigation keys	<p>Navigation Keys</p> <ol style="list-style-type: none"> 1. Scroll the information or options displayed on the screen. 2. You can quickly access historical records and directories. <p>OK key</p> <ol style="list-style-type: none"> 1. Can quickly enter the menu 2. Save the configuration 3. Answer the call <p>Cancel key</p> <ol style="list-style-type: none"> 1. Cancel actions 2. Reject the call 3. To return to idle screen. <p>Up arrow key: To move up of the selection shows on</p>

	<p>the screen.</p> <p>Right arrow key: To move right of the selection shows on the screen.</p> <p>Left arrow key: To move left of the selection shows on the screen.</p> <p>Down arrow key: To move down of the selection shows on the screen.</p>
Mute key	<ol style="list-style-type: none"> 1. To mute the voice during the call (Red light). 2. To un-mute the call.
Conference	To place a conference call
Line keys	<p>To be configured as different function as:</p> <ul style="list-style-type: none"> Line Speed Dial BLF BLF List Voice Mail Direct Pickup Group Pickup Call Park Intercom DTMF Prefix Local Group XML Group XML Browser LDAP Network Directories Conference Forward Transfer Hold DND Redial Call Return SMS Record URL Record

	<p>Group Listening</p> <p>Public Hold</p> <p>Private Hold</p> <p>Hot Desking</p> <p>ACD</p> <p>Zero Touch</p> <p>URL</p> <p>Network Group</p> <p>Multicast Paging</p> <p>Group Call Park</p> <p>CallPark Retrieve</p> <p>XML BLF</p> <p>Silent Call</p> <p>Smart BLF</p>
Speaker	Press this button to place a call in hands-free mode.
Redial	<p>To dial the previous dialed number.</p> <p>To act as send key.</p>
Volume	<p>To decrease the volume.</p> <p>To increase the volume.</p>
Hold	To hold or to resume a call during a conversation.
Transfer	<p>To transfer a call to a third party.</p> <p>To enable or disable Forward feature during the idle page.</p>
Alphanumeric keypad	To enter the phone numbers, letters and so on.
Message	To indicator the New message, and press to read.
Headset	To indicate that the phone is or not in Headset mode.

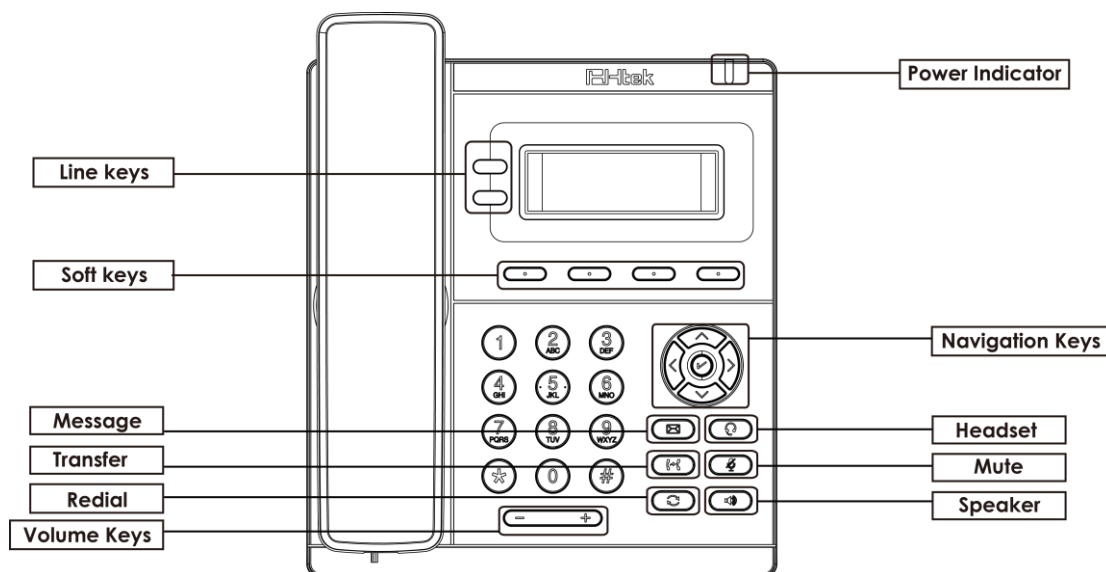

Item	Description
LCD screen	To present all information about the date& time, accounts, soft keys, messages, calls and other some information.
Power Indicator LED	To indicate the power status
Line Keys	The phone supported up to 2 accounts Steady green: during a call. Blink red: a call incoming
Soft Keys	Labels automatically to identify their context-sensitive features.
Navigation Keys	<p>OK key</p> <ol style="list-style-type: none"> 1. Can quickly enter the menu 2. Save the configuration 3. Answer the call <p>Up arrow key: To move up of the selection shows on the screen.</p> <p>Right arrow key: To move right of the selection shows on the screen.</p> <p>Left arrow key: To move left of the selection shows on the screen.</p> <p>Down arrow key: To move down of the selection shows on the screen.</p>
Line Keys	To be configured as different function as: Line Speed Dial BLF

	BLF List
	Voice Mail
	Direct Pickup
	Group Pickup
	Call Park
	Intercom
	DTMF
	Prefix
	Local Group
	XML Group
	LDAP
	Network Directories
	Conference
	Forward
	Transfer
	Hold
	DND
	Redial
	Call Return
	SMS
	Record
	URL Record
	Group Listening
	Public Hold
	Private Hold
	Hot Desking
	ACD
	Zero Touch
	URL
	Network Group
	Multicast Paging
	Group Call Park
	Call Park Retrieve
	XML BLF
	Silent Call
	Smart BLF
Alphanumeric Keypad	To enter the phone numbers, letters and so on.

Message	To indicator the New message, and press to read.
Transfer	1.To transfer a call to a third party. 2.To enable or disable Forward feature during the idle page.
Redial	1. To dial the previous dialed number. 2. To act as send key.
Volume Keys	To decrease the volume. To increase the volume.
Headset	To indicate that the phone is or not in Headset mode.
Mute	1. To mute the voice during the call (Red light). 2. To un-mute the call.
Speaker	Press this button to place a call in hands-free mode.

Idle Screen

UC926(U/S/E)

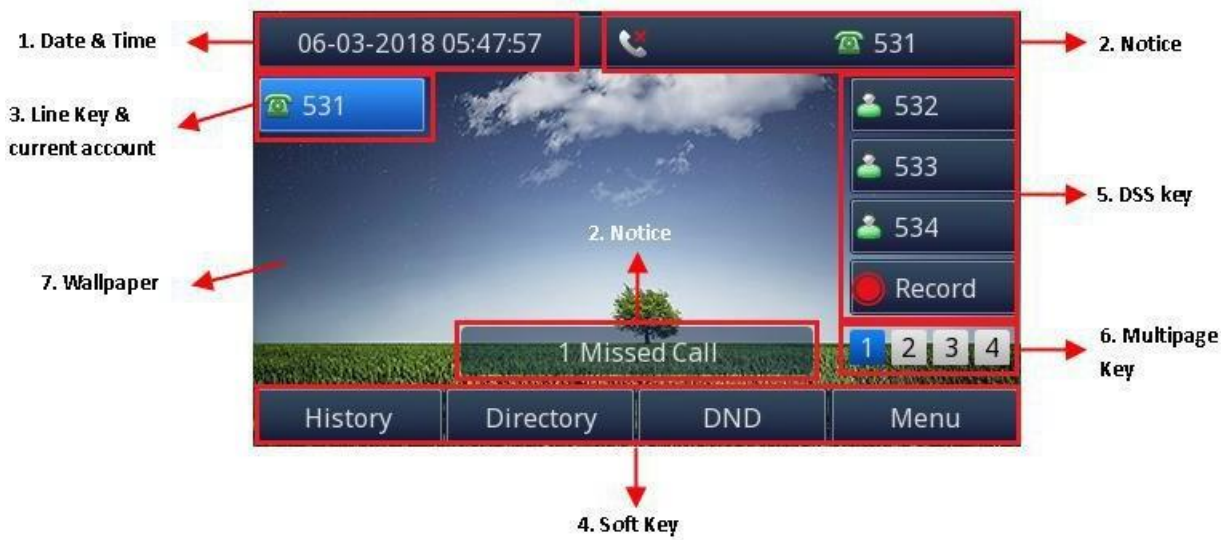



UC924(U/S/W)





UC921(U/E/G/P)



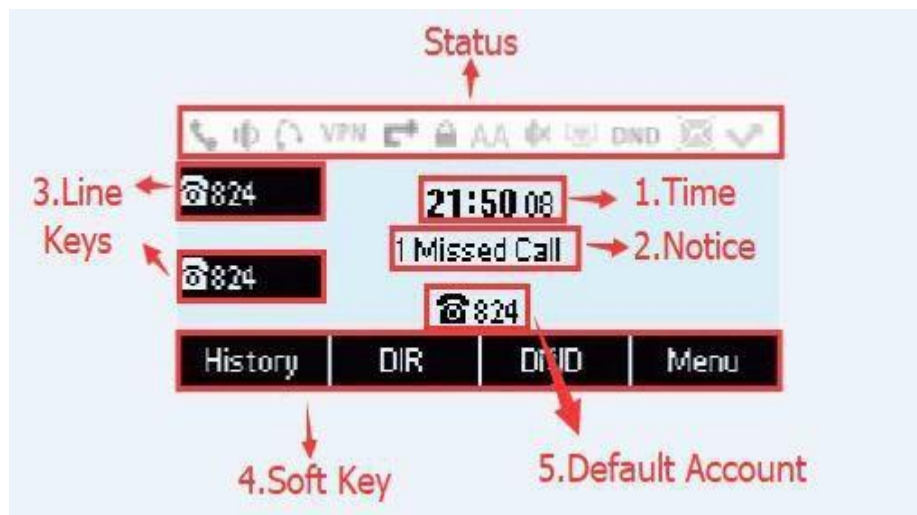

Name	Description
1. Date & Time	It is the area that displays the current set date and time of the phone.
2. Notice	It is the area to display the phone's notifications such as missed calls, SMS, do not disturb mode and many more. For more info, see Icon Preview .
3. Line Keys	This area shows the line key labels. The Line keys can also be used for other function keys. For more info, you can refer to Line Keys
4. Soft Keys	This area shows the soft key labels. The default soft key labels are "History", "Directory", "DND" and "Menu". For more info, see Programmable Key
5. Default Account	This shows the current use account. User can use   to change the default use account.
6. Multipage Key	UC926U support 36 keys, UC924U support 28 keys, UC923U support 20 keys. you can configure different types. You can view and use these keys by pressing the multipage key.
7. Wallpaper	This shows the current wallpaper picture. You can also change it. For more info, you can refer to Wallpaper .

UC912(E/G/P)/UC903

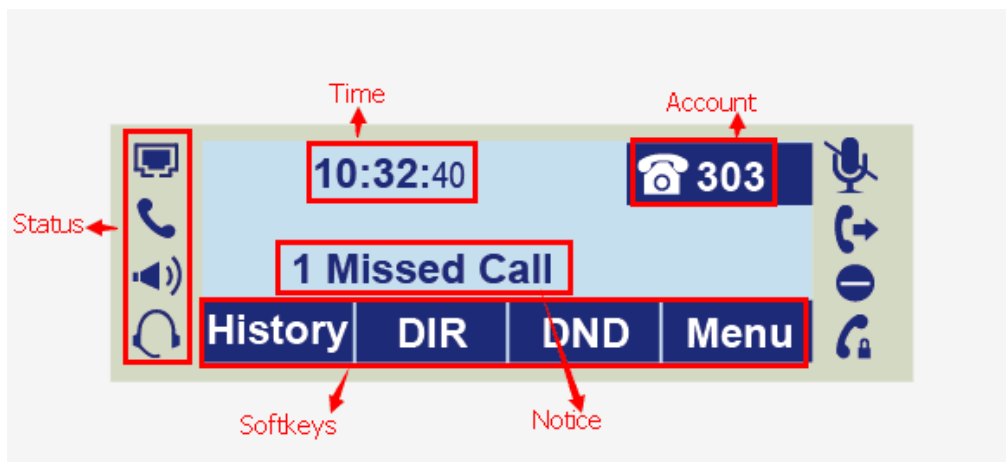



Name	Description
1. Date&Time	It is the area that displays the current set date and time of the phone.
2. Notice	It is the area to display the phone's notifications such as missed calls, SMS, do not disturb mode and many more. For more info, see Icon Preview .
3. Line Keys	This area shows the line key labels. Line keys are also can be used as other function keys. For more information you can refer to Line Keys
4. Soft Key	This area shows the soft key labels. The default soft key labels are "History", "Directory", "DND" and "Menu". For more information, see Programmable Key
5. Default Account	This shows the current account. User can use  or  to change the default account.

Initialization Process

After your phone has been powered up, the system boots up and performs the following steps:
Automatic Phone Initialization.

The phone finishes the initialization process by loading the saved configuration. The phone LCD screen will display “Booting”.



Then show “Initializing” during the initialization, and all the indicators on the phone LCD are always on.



Status

You can view the system status of your phone via phone user interface or web user interface. The information of phone status includes: Information (e.g., Model, IPV4, IPV6, MAC, Firmware, Hardware), Network (e.g., WAN Type, IP, Mask, LAN Type, Gateway, DNS ...), Accounts (e.g., register status of accounts)

To view the phone status via Phone interface:

1. Press Menu→ Status→ Information

Information	
1. Model:	UC926
2. IPV4:	10.3.4.88
3. MAC:	00:1f:c1:1f:34:c2
4. Wifi MAC:	cc:4b:73:db:29:76
5. Firmware (IMG):	2.20.10.22.4(2020-10-22 00:11:1)

Back

2. Press Menu→ Status→ Network

Network	
1. IPV4	
2. IPV6	
3. IP Port Mode:	IPV4&IPV6
4. LAN Type:	Bridge mode
5. MAC:	00:1f:c1:1f:a7:ee

Back Enter

3. Press Menu→ Status→ Network→ IPV4

IPV4	
1. WAN Type:	DHCP mode
2. WAN IP:	10.3.4.88
3. WAN Mask:	255.255.0.0
4. Gateway:	10.3.0.1
5. Pri.DNS:	192.168.0.230

Back

4. Press Menu→ Status→ Network→ IPV6

IPV6	
1. WAN Type:	DHCP mode
2. WAN IP:	
3. WAN Mask:	
4. Gateway:	/64
5. Pri.DNS:	
<input type="button" value="Back"/> <input type="button" value=""/> <input type="button" value=""/> <input type="button" value=""/>	

1. Press Menu→ Status→ Accounts

Accounts	
1. 024:	Registered
2. Empty:	Not Registered
3. Empty:	Not Registered
4. Empty:	Not Registered
5. Empty:	Not Registered
<input type="button" value="Back"/> <input type="button" value=""/> <input type="button" value=""/> <input type="button" value=""/>	

To view the phone status via Web interface:

1. Login webpage
2. Input the IP Address in the web browser.
3. Input the user name (default is admin), password (default is admin).
4. Login successfully.

View the information of Version, Account Status and Network.

[logout](#)

Home | Profile | Account | Network | Function Keys | Setting | Directory | Management

Status

- **Version** ?

Product Model	UC926
Firmware Version	BOOT--2.42.0.52(2020-12-21 12:35:00) IMG--0.0.0.1(Dec 21 2020 12:33:43) ROOTFS--2.42.0.52(2020-12-21 12:35:00) ROM--2.42.0.52.9(2020-12-21 12:35:00) DSP--9.0.3(Patch 1.0.16D)

NOTE

Version:
Shows product type and the version of firmware.

Account Status:
Shows the registered status of accounts.

Note:

The PC and phone should be in the same segment.
 When registering the accounts in web and the server port is not“5060”,the SIP Server should be set as SIP Server’s IP address:server port,for example, 192.168.0.12:5090.

To register via Phone interface

1. Press Menu→ Settings→ Advanced (default password: admin)→ Accounts
2. Select the desired account.
3. Select Enable for Active.
4. Select the desired Profile of the account.
5. Fill in the SIP User ID, Authenticate ID.
6. Fill in the Password and Name (shown on LCD).
7. Press Save soft key to save the configuration.

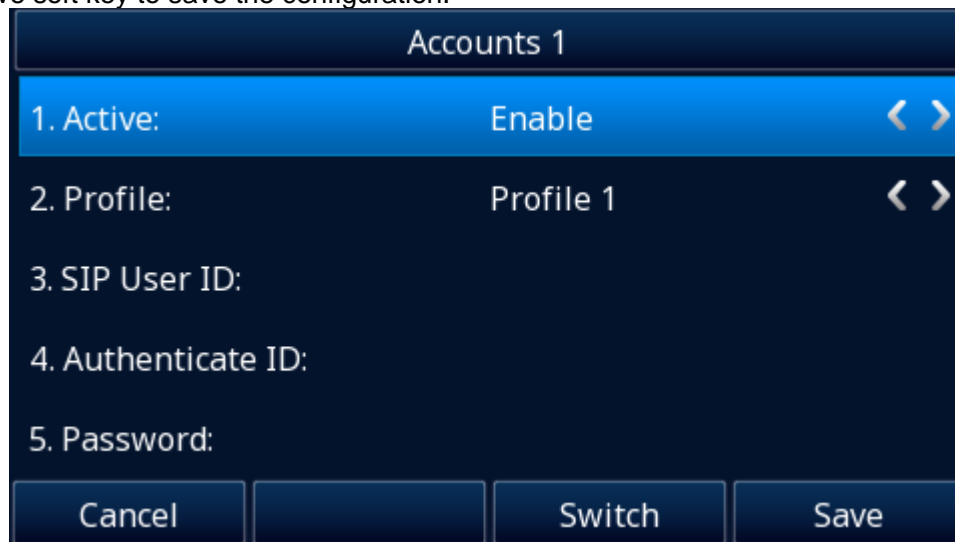

Accounts 1		
1. Active:	Enable < >	
2. Profile:	Profile 1 < >	
3. SIP User ID:		
4. Authenticate ID:		
5. Password:		
Cancel	Switch	Save

Note:

If there is a port of sip server, you need to press “1” on the keypad, then you will find the “:”.

Additional Information

When the current input method is ABC/abc/2ab,

Pressing “1”, you will find “, . ? : ;”

Pressing “0”, you will find “< > () { } [] _ -”

Pressing “*”, you will find “*^ “ ! @ \$ = + ‘ % & | ~ ^”

Pressing “#”, you will find “#”

To register via Web interface

1. Login webpage and Click Profile→ Basic
2. Select the desired profile from the pull-down list of Profile field.

Basic
Codec
Advanced

Profile Profile 1

* Primary SIP Server ?

Failover SIP Server ?

Prefer Primary SIP Server No Yes ?

Current SIP Server

DHCP SIP Server No Yes

Outbound Proxy ?

Backup Outbound Proxy ?

* SIP Transport UDP TCP TLS ?

NAT Traversal No No, but send keep alive STUN

DNS Mode A Record SRV NAPTR/SRV

Call Message Format Regular

Transfer Release Trigger: NOTIFY with 200OK

SIP Registration No Yes

Unregister On Reboot No Yes

Register Expiration 15 ?

Fallback Interval 60 ?

Server Retry Counts 3 ?

Outgoing Call Without Registration No Yes

RPort No Yes

RFC 2543 Hold No Yes

3. Fill in the Primary SIP Server and other profile information.
4. Select the SIP Transport.
5. Click to save the configuration.
6. Click Account → Basic.
7. Select the desired account from the pull-down list of Account field.

Basic

Account Account 6

Account Status Disabled

* Account Active No Yes

Profile Profile 1

Label ?

* SIP User ID ?

* Authenticate ID ?

* Authenticate Password ?

Name ?

Local SIP Port 5560 ?

Use Random Port No Yes

Voice Mail UserID ?

Dial Plan {[x*]+}

Eventlist BLF URL

Shared Line Disable

SCA Barge-In Disable ?

Direct Call Pickup Code

Group Call Pickup Code

Feature Key Sync Disable

8. Select Yes for Account Active.
9. Select the desired Profile.
10. Fill in the SIP User ID, Authenticate ID, Authenticate Password and other account information.
11. Click to save the configuration.

To register via DHCP SIP Server

1. Login web page and Click Profile→ Basic
2. Select the desired profile from the pull-down list of Profile field.

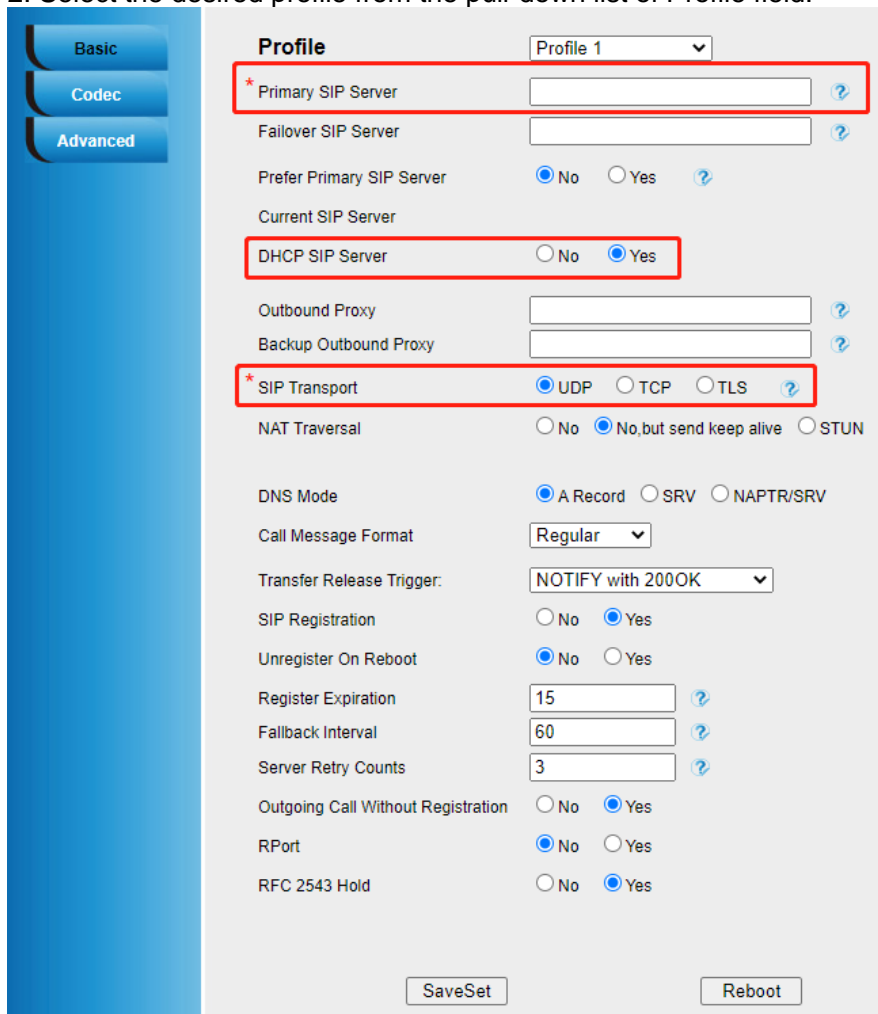

3. Fill in the Primary SIP Server and other profile information.
4. Select Yes for the DHCP SIP Server and select the SIP Transport.
5. Click to save the configuration.
6. Click Account→ Basic.
7. Select the desired account from the pull-down list of Account field.

8. Select Yes for Account Active.
9. Select the desired Profile.
10. Fill in the SIP User ID, Authenticate ID, Authenticate Password and other account information.
11. Click to save the configuration.

























Note:















1. All fields with * must be filled.
2. Account Status says the account registered successfully or not.

Getting Familiar with Your Phone

Icon Preview

Icon	Description	Icon	Description
	Network down		Call Park
	Line(Registered succeed)		Intercom
	Line (Unregistered)		Prefix
	Line(Ringing)		XmlGroup
	Speed Dial		LocalGroup
	BLF(No subscription)		XmlBrowser
	BLF(Free)		LDAP
	BLF(Ring)		Broadsoft Group
	BLF(Talking)		Forward
	Speakerphone mode		Transfer
	Handset mode		Redial
	Headset mode		Call Return
	Voice mail		Record
	Text message		Stop Recording

	Mute		Group Listening
	DND		Multipaging
	Volume is 0		ParkRetrieve
	SRTP		Share Line
	Hold(DSS key)		SMS
	hold		URL
	Dialed/PickUp		Bluetooth mode is on
	Received calls		Bluetooth headset is both paired and connected
	Missed calls		VPN
	Forward		Wi-Fi obtaining
	Conference		Wi-Fi connection is successful
	Keypad locked		Wi-Fi Disconnected
	DTMF		Other Functions

Icon	Description
	Network
	Line(Registered succeed)
	Line(Unregistered)
	Speakerphone mode
	Handset mode
	Headset mode
	Mute
	Forward
	Do Not Disturb
	SRTP
	Received calls
	Dialed Calls
	Missed calls
	Forward calls

LED Instruction

This part mainly instructs the LED status. The Power LED Status describe on the premise that the LED setting all set as Yes. For LED status setting, please refer to: [LED Status Setting](#)

The Power LED of UC926(E/U),UC924(U/E/W),UC923(U) has two colors, the Power LED of the others only has one color.

Power Indicator LED

LED Status	Description
Fast flash green	LED flash the green light quickly
Slow flash green	LED flash the green light slowly
Steady Green	LED keep green light on
Fast flash red	LED flash the red light quickly
Slow flash red	LED flash the red light slowly
Steady Red	LED keep red light on
Off	Powered off

Line LED (Line Key set as Line)

LED Status	Description
Slowly-flashing green	The call is placed on hold.
Steady Green	Off hook or during a conversation.
Fast-flashing red	The line receives an incoming call.
Off	Idle status

BLF or BLF List Key LED (Line/Line Key set as BLF)

LED Status	Description
Steady Green	Idle status for the monitored line.
Steady Red	The monitored line is in the conversation or making a call.
Blinked red	The monitored line is receives an incoming call.

Off	No subscription or Account dropped.
-----	-------------------------------------

Shared Line LED

LED Status	Description
off	Idle status
Stay green	a member of the SCA group in off-hook status
Stay red	Other member of the SCA group's led status when a member of the SCA group in off-hook status
Blinked green every 500ms	a member of the SCA group in Private hold status.
Stay red	Other member of the SCA group's led status when a member of the SCA group in Private hold status
Blinked green every 500ms	a member of the SCA group in public hold status
Blinked red every 500ms	Other member of the SCA group's led status when a member of the SCA group in public hold status
Blinked green every 500ms	a member of the SCA group in progressing status
Stay red	Other member of the SCA group's led status when a member of the SCA group is in progressing status.
Blinked red every 100ms	Alerting
Stay green	a member of the SCA group in active status when there is an incoming call designated for the SCA group
Stay red	Other member of the SCA group's led status when a member of the SCA group in active status

User Interface

There are two ways to customize specific configurations on your IP phone:

- The user interface on the IP phone
- The user interface in a web browser on your PC

The hardware components keypad and LCD screen constitute the phone user interface, which allows the user to execute all call operation tasks and basic configuration changes directly on the phone. In addition, you can use the web user interface to access all configuration settings. In many instances, it is possible to use both the phone user interface and the web user interface to operate the phone and change settings. However, in some instances, it is only possible to use the phone or the web user interface.

Phone Interface Overview

Option	
Status	Information
	Network
	Accounts
Features	Forward
	Function Keys

		More Key see Line Key Overview		
		# as Send Key		
		Hot Line		
		Anonymous Call		
		DND		
		History		
Directory		Local Contacts		
		Remote Contacts(When you use remote, It will display)		
		AP Contacts(When you use AP contacts, It will display)		
		LDAP Contacts(When you use LDAP, It will display)		
		BlackList		
History		All Calls/Missed Calls/Dialed Calls/Received Calls/Forwarded Calls		
Messages		Voice Mail		
		SMS		
Settings		Language		
		Time & Date		
		Time & Date Format		
		DHCP Time		
		Ring Tone		
		Headset		
		Bluetooth (Built-in: UC926U/ UC926E/ UC924U/ UC924W/ UC924E/ UC921E/ UC912E; With dongle WFBT60: UC926S/ UC924U/ UC923U/ UC921U)		
		Wi-Fi (Built-in: UC926U /UC926E /UC924U /UC924W /UC924E /UC921E /UC912E /UC902E; With dongle WFBT60: UC926S/ UC924U/ UC923U/ UC921U)		
		Font Size		
		Text Scroll		
		Advanced Setting		Accounts
				Network
				Phone Setting
				Auto Provision
		Display		Wallpaper
Screensaver				
Backlight				
Others		Factory Function		
		Restart		
		Reboot		

Call Features

Place a Call

There are three ways to dialing a call: Handset, Headset and Speakerphone.

To place a call by Handset:

1. Pick up the handset.
2. Enter the number.
3. Press the Send soft key.

To place a call by Headset:

1. Press the Handset hard key  (light will be green).
2. Enter the number.
3. Press the Send soft key.

Using headset to place and answer calls for all time:

1. Log into the webpage and click **Setting** → **Preference**.
2. Set **Headset Priority** to **Enable**.
3. Set **Ring Device For Headset** to **User Headset**.

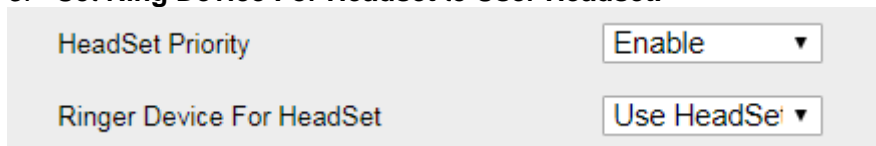

HeadSet Priority	Enable ▼
Ringer Device For HeadSet	Use HeadSet ▼

4. Click **SaveSet** to save the setting.
5. Press Headset  key to activate the Headset priority mode.

To place a call by speakerphone:

1. Press the Speakerphone key , or press the Line key, then you can hear the dial tone.
2. Press the number.
3. Press the Send soft key.

To place a call from Call History:

1. Press the History soft key or navigate to Menu → History → Local History.
2. Select the desired call history.
3. Press the Send soft key.

To place a call from Directory:

1. Press the Directory soft key or navigate to Menu → Directory → Local Contacts.
2. Select the desired contact from a contact group.
3. Press the Send soft key.

Note:

1. The  key can be set as **Send** key. For more information, refer to [Key as Send](#).
2. During a call, you can also change among Headset, Handset or Speakerphone mode.

Making multiple calls

When you are in a call, you can hold your current call and place a new call.

1. Press Hold soft key to place the current call on hold.
2. Press New Call soft key.
3. Dial another number,
4. Press the Send soft key.

End a Call

Here shows to end a call during three modes:

To end a call by Handset

In handset mode, press the **EndCall** soft key or hang up the handset.

To end a call under Headset Mode

In headset mode, press the **EndCall** soft key or press .

To end a call under Speakerphone Mode

In speakerphone mode, press the **EndCall** soft key or press .

Note:

During the conference, to end the call is same as mentioned above.

Redial a Call

To redial the last placed call from the IP Phone:

Press  directly when LCD is on the idle interface.

Receive a Call

There are three ways to receive a call when the phone is ringing:

To receive a call by handset

Pick up the handset.

To receive a call by headset

Press the Headset key .

To receive a call by speakerphone

1. Option 1: Press  directly.
2. Option 2: Press Answer soft key.
3. Option 3: Press the Line key (flashing red indicator by default).

Moreover, some other action can be done by soft key when the call is coming.

1. Press the Reject soft key to reject the call.
2. Press Forward soft key to forward to another phone.
3. Press Silence soft key, the call will stop ringing, but the incoming call notification will continue to display.

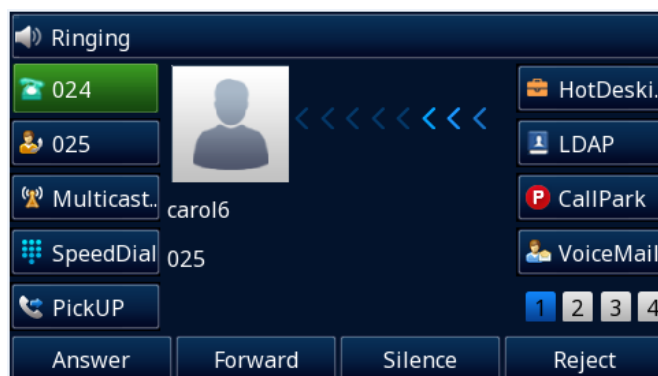

Incoming Call Show Mode

There are three incoming call show modes:

1. name of the contacts
2. name and number of the contacts
3. name and number of the incoming call and the account which is connecting

To set Incoming Call Show Mode via Web interface:

1. Click **Setting** → **Preference**.
2. Select the desired mode for the Incoming Call Show Mode.
3. Click **SaveSet**.

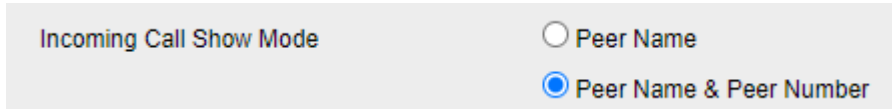

Incoming Call Show Mode

Peer Name

Peer Name & Peer Number

Auto Answer

Auto Answer will allow the phone answers incoming calls automatically.

To enable Auto Answer via Web interface:

1. Click **Profile** → **Advanced**.
 - a) (if you want to set profile except Profile 1, please select the corresponding profile from the pull-down list in the Profile field)
2. Switch the option to **Yes**.

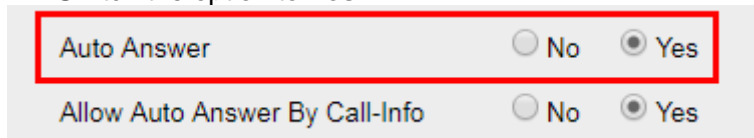

Auto Answer No Yes

Allow Auto Answer By Call-Info No Yes

3. Click **SaveSet**.

Call Hold/Resume

When using the Hold feature, the held party may hear music played by the server.

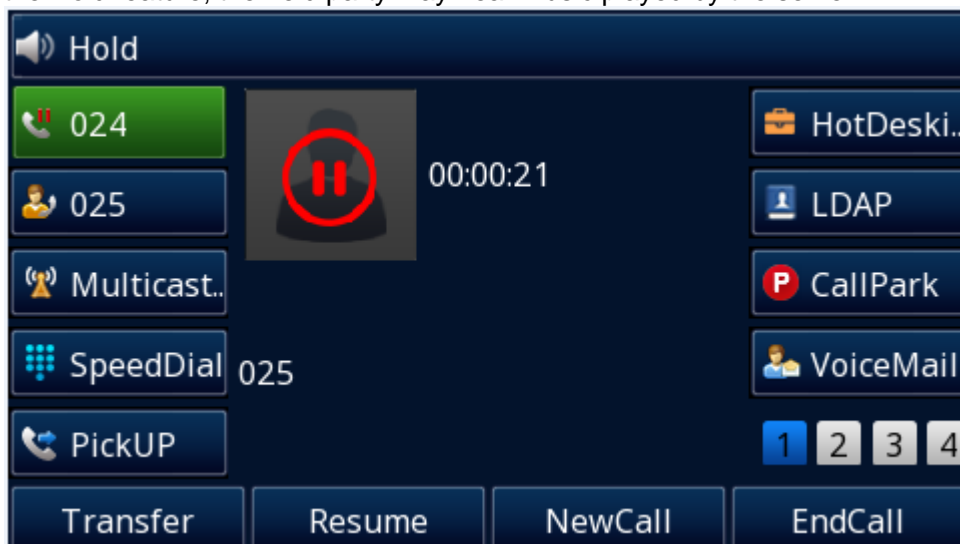

To hold/resume a call:

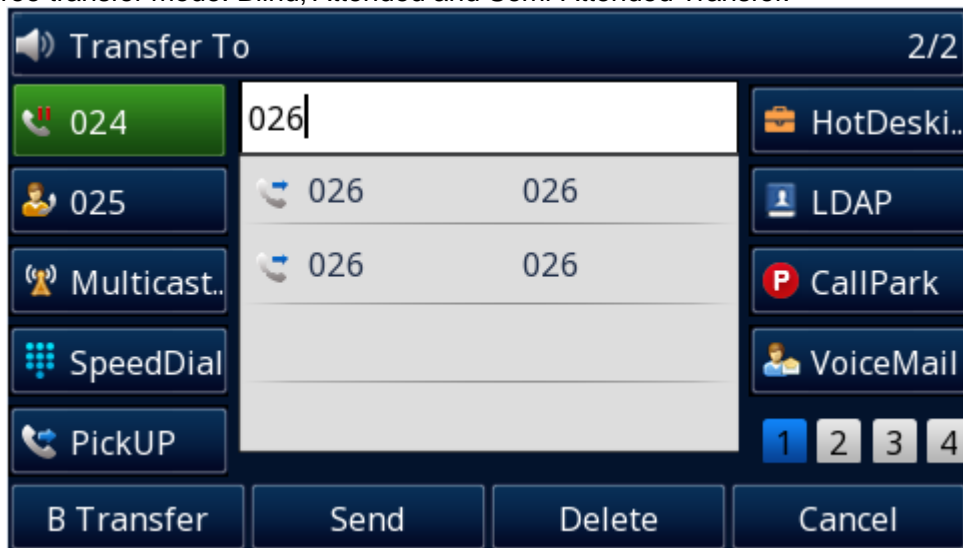

1. Press Hold soft key to hold the current call.
2. Press Resume soft key to resume the call on hold.

There are three transfer mode: Blind, Attended and Semi-Attended Transfer.





Blind Transfer

When you are in a call,

1. Press  or **Transfer** soft key, the current call will be holding.
2. Enter the number you want to transfer to.
3. Press  or **B Transfer** soft key to complete the blind transfer.



Attended Transfer

When you are in a call,

1. Press  or **Transfer** soft key, the current call will be holding.
2. Enter the number you want to transfer to.
1. Press **Send** soft key.
2. After the second call established, press  or **Transfer** soft key to complete the attended transfer.

Semi-Attended Transfer

When you are in a call,

1. Press  or **Transfer** soft key, the current call will be holding.
2. Enter the number you want to transfer to.
3. Press **Send** soft key.
4. When you hear the ringback tone, press  or **Transfer** soft key to complete the semi-attended transfer.

BLF Transfer

This feature controls the operation when you press the BLF key during a call. There are three mode:

- Attended Transfer
- Blind Transfer
- New Call

To set this feature, enter **Setting** → **Features** → **Transfer Settings** → **Transfer Mode via DSSkey**.

Transfer Settings

Blind Transfer On Hook On Off

Semi-Attended Transfer On Off

Attended Transfer On Hook On Off

Semi-Attended Transfer Mode On Off

Transfer Mode via DSSkey ▼

Hold Transfer On Hook On Off

Relates to [BLF](#)

Override Transfer On Hook:

There are two calls at the same time, and one is in talking, another one is on held. This feature allows you to transfer the current talking call to the held call by hanging up the handset.

How to configure

1. Log into webpage, **Setting** → **Features** → **Transfer Settings** → **Override Transfer On Hook**.
2. Switch the option to On.
3. In the same webpage, **Setting** → **Features** → **Transfer Settings** → **Attended Transfer On Hook**.
4. Switch the option to On.

Transfer Settings

Blind Transfer On Hook On Off

Semi-Attended Transfer On Off

Attended Transfer On Hook On Off

Semi-Attended Transfer Mode On Off

Transfer Mode via DSSkey ▼

Override Transfer On Hook On Off

Transfer Code Control On Off

Attend Transfer Code

Blind Transfer Code

How to use

1. A enables the Override Transfer On Hook feature.
2. During the conversation with B, A presses the Hold soft key and establishes a new call with C.
3. A hung up the handset.
4. The call will transfer to C and B.

Three Way Call Release Type:

This feature allows the participants of a local conference to keep talking when the chairman leave.

How to configure

1. The chairman should login webpage, **Setting** → **Preference** → **Three Way Call Release Type** → **Transfer**.

How to use

1. There is a 3-way conference.
2. The chairman press **EndCall** to exit the conference.
3. The two participants can continue to talk.

Three Way Call Release Type ▼

Transfer Release Trigger

This option defines the time when the phone sends BYE to the server to release the transferred call.

How to configure

Log into webpage, **Profile** → **Basic** → **Transfer Release Trigger**.

1. NOTIFY with 200OK

After receiving REFER request send by phone, the server will send NOTIFY to the phone, and the phone response 200 OK, this is the trigger for the phone to release the call.

2. 2xx response of REFER

The phone will not release the call until it receives a 2xx response from the server to the phone's REFER request.

3. BYE for the call

The phone will not release the call until receiving BYE from the server.

Transfer Release Trigger:

NOTIFY with 200OK

Call Conference

This IP Phone supports up to 5-way conference.

5-way conference

1. Assuming that call party **A** and **B** are in conversation. **A** want to bring **C**, **D** and **E** in a conference

2. **A** press the Conf soft key, the call is placed on hold.

3. **A** enter the number of **C** and then press Send soft key or .

4. **C** answer the call.

5. **A** press the Conf soft key, then **A**, **B** and **C** are now in a conference. (and now this is **3-way conference**)

6. **A** press the Conf soft key, the current 3-way conference is placed on hold.

7. **A** enter the number of **D** and then press Send soft key or .

8. **D** answer the call.

9. **A** press the Conf soft key, then **A**, **B**, **C** and **D** are now in a conference. (and now this is **4-way conference**)

10. **A** press the Conf soft key, the current 4-way conference is placed on hold.

11. **A** enter the number of **E** and then press Send soft key or .

12. **E** answer the call.

13. **A** press the Conf soft key, then **A**, **B**, **C**, **D** and **E** are now in a conference. (and now this is **5-way conference**)

14. **A** end the call, the conference is finished.

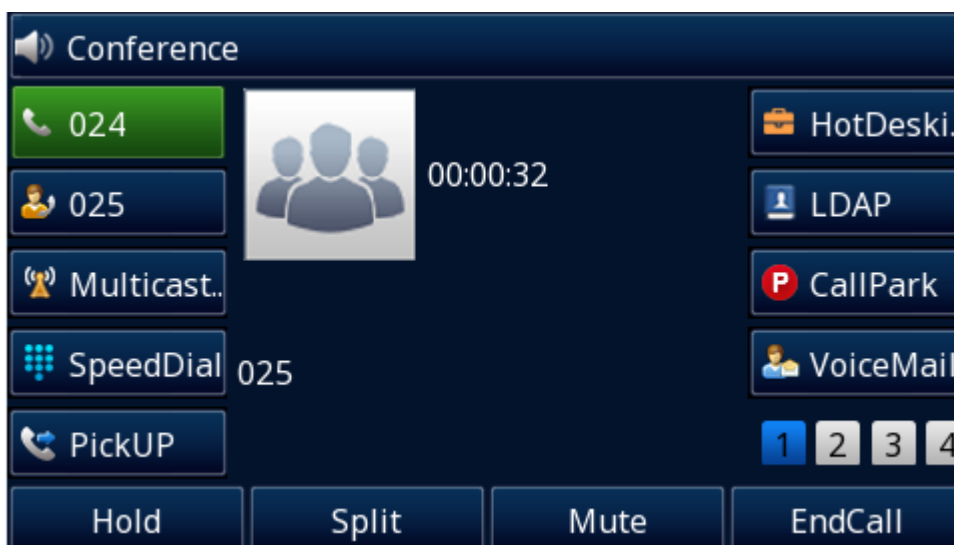

Note:

1. If **C** does not answer the call, **A** can back to continue the conversation with **B**;
2. Once **A** hangs up the call, the conference is ended, while if **B** or **C** drops the call, **A&C** or **A&B** continues the conversation.
3. The conference feature is not available on all servers. For more information, contact your system administrator.
4. To realize the 5-way conference, the line should be all available.



Call Forward

This phone supports static forward (always forward, busy forward and no answer forward) and dynamic forward.

To configure static forward

To configure always forward via Phone interface:

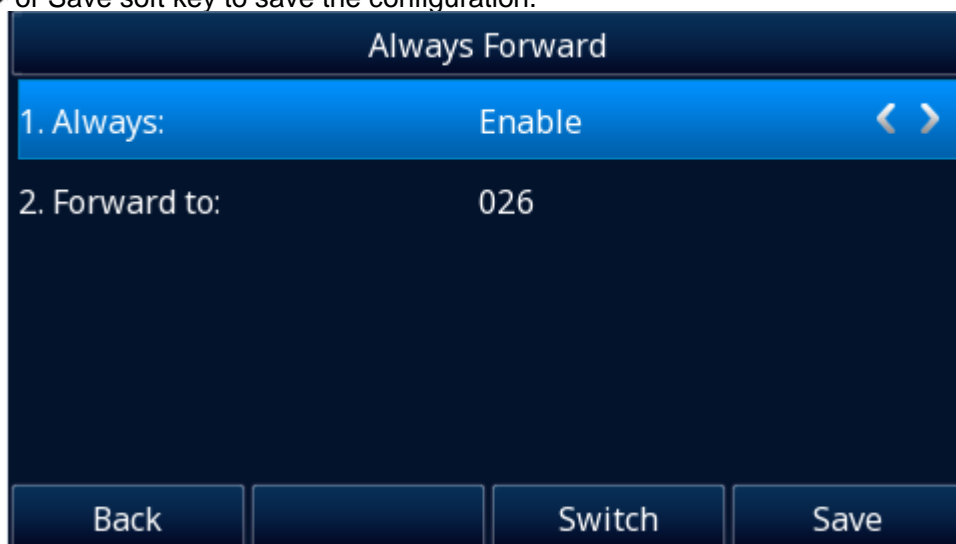

With this feature, all incoming calls will forward immediately to configured number.

1. Press Menu→ Features→ Forward→ Always.
2. Press  and  to select the Enable choice.
3. Enter the Forward to number.
4. Press  or Save soft key to save the configuration.



To configure busy forward via Phone interface:

With this feature, the incoming calls are immediately forwarded if the phone is busy.



1. Press Menu→ Features→ Forward→ Busy.
2. Press  and  to select the Enable choice.
3. Enter the Forward to number.
4. Press  or Save soft key to save the configuration.

Busy Forward	
1. Busy:	Enable < >
2. Forward to:	026
Back Switch Save	

To configure no answer forward via Phone interface:

No Answer Forward: Incoming calls are forwarded if not answered after some time.

1. Press Menu→ Features→ Forward→ No Answer.

2. Press  and  to select the Enable choice

3. Enter the Forward To number and After Ring Times.

No Answer Forward	
1. No Answer:	Enable < >
2. After Ring Times:	6
3. Forward to:	026
Back Switch Save	

4. Press  or Save soft key to save the configuration.

When the Forward feature is enabled, the Icon  will display on Top of the LCD.



To configure Forward via Web interface

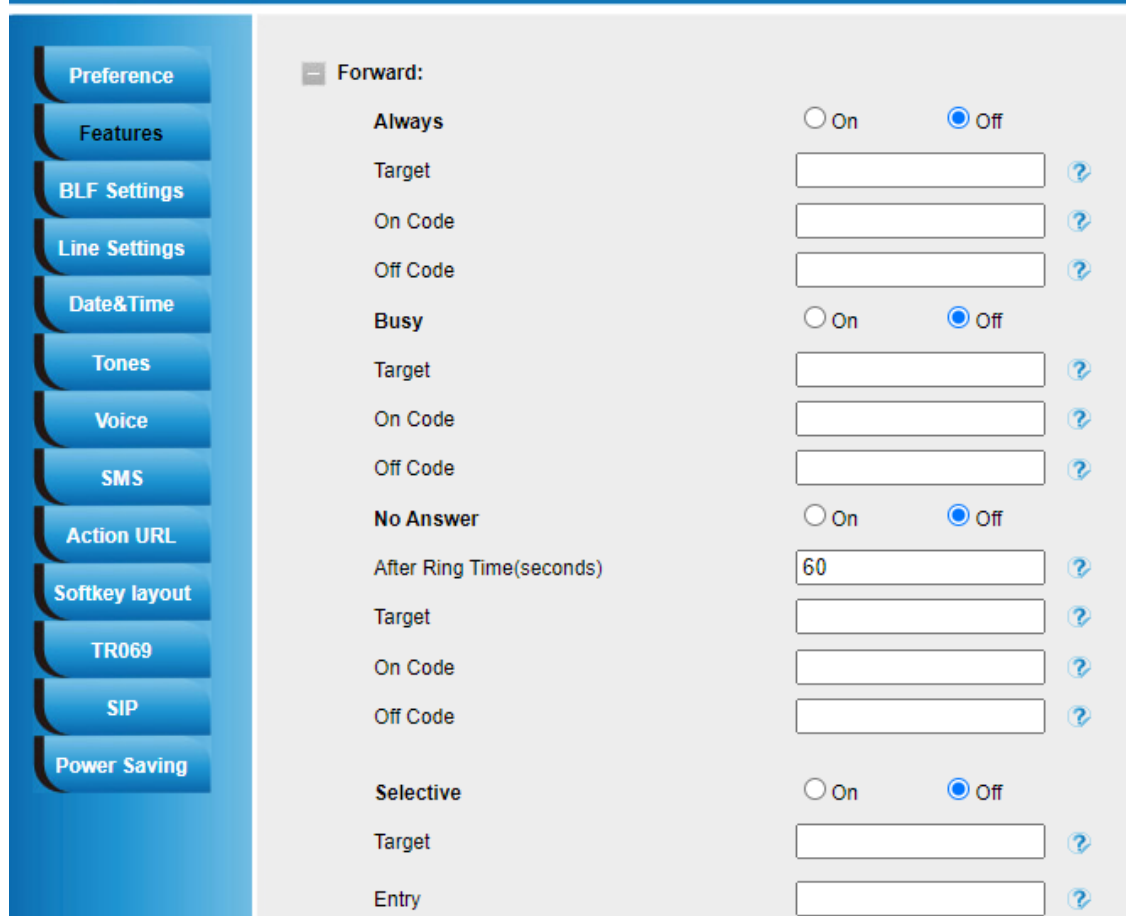

1. Setting→ Features
2. Click On for the Always/Busy/No Answer
3. Fill in the Target number.
4. Fill in the After Ring Time.
5. Fill in the On Code and Off Code (optional).
6. Click to save the configuration.

Note: you should set **DND Work Type** to Server or Mixed if you need to set the forward code.



To cancel the forward feature via Phone interface

1. Option 1: To press the key to disable the forward feature.
2. Option 2: Press Menu→ Features→ Forward→ Always/Busy/No Answer

- a. Press  and  to select the Disable choice
- b. Press  or Save soft key to save the configuration.

To cancel the forward feature via Web interface

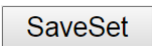
1. Setting→ Features
2. Click Off for the Always/Busy/No Answer
3. Click  to save the configuration

To configure dynamic forward

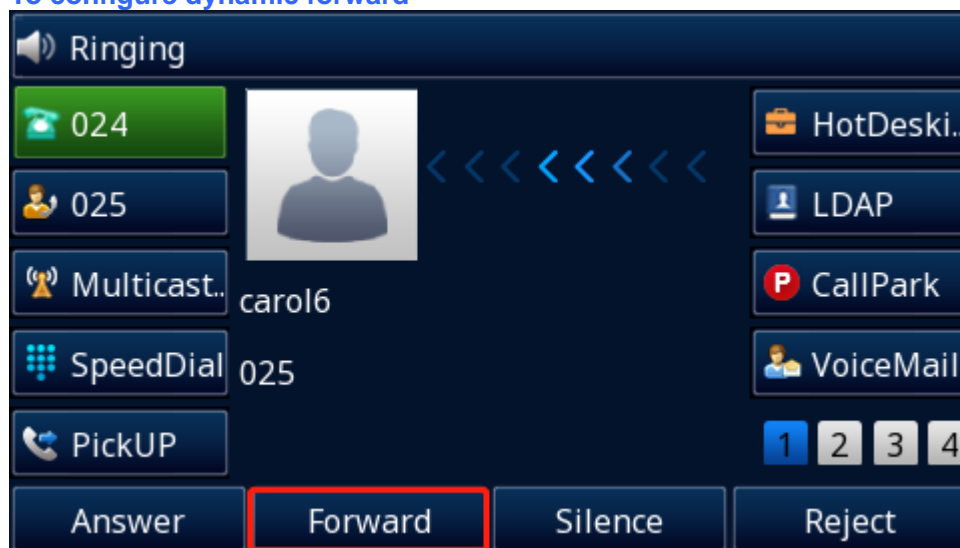

Forward an incoming call during the ringing.

1. When the phone is ringing, press Forward soft key.
2. Enter the forward number or select the desired number from Directory soft key (Precondition: local directory has one or more contacts).
3. Press  or press the Send soft key, then the call is forwarded.



Note:

1. If the Programmable Key or line key is set as BLF, when an incoming call ringing, press this BLF key directly to realize the dynamic forward.
2. You can choose a desired forward number from the Directory when you press the Forward key.

Call Return

This feature allows you to dial the last phone call you missed.

To configure the Call Return via Phone interface

1. Press Menu→ Features→ Function Keys→ Line Keys as Function Keys→ Line Key2(for example)
2. Press  and  key to select the Call Return in the Type field.
3. Press  or Save soft key to save the configuration

To configure the Call Return via Web interface

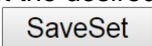
1. Click Function Keys→ Line Key.
2. Select the desired Line Key and select Call Return in the Type field.
3. Click  to save the configuration.

Line	Type	Mode	Value	Label	Account	Extension
Key1	Line	Default		243	Account 1	
Key2	Call Return	Default			Account 1	

Call Waiting Tone

To enable the Call Waiting and Call Waiting Tone via Web interface

1. Click Setting→ Features
2. Select Call Waiting: On and Call Waiting Tone: On

Call Waiting

Call Waiting On Off

Call Waiting Tone On Off

To Change the Call Waiting Tone time via Web interface

1. Click Setting→ Tones

Select Country: Custom

Dial Tone: f1=350@-13,f2=440@-13,c=0/0/;

Ringback Tone: f1=440@-19,f2=480@-19,c=2000/4000/;

Busy Tone: f1=480@-24,f2=620@-24,c=500/500/;

Reorder Tone: f1=480@-24,f2=620@-24,c=250/250/;

Confirmation Tone: f1=350@-11,f2=440@-11,c=100/100-100/100-100/100/;

Call Waiting Tone: f1=440@-13,c=300/10000-300/10000-0/0/;

Syntax: f1=freq@vol, f2=freq@vol, c=on1/off1-on2/off2-on3/off3; [...]
 Note: freq: 0 - 4000Hz; vol: -30 - 0dBm



2. Change the Tone Time as you want (for example 3s)

Call Waiting Tone: f1=440@-13 **c=300/10000-300/10000-0/0/;**

Hide Caller ID



Just enable the unknown/hidden caller feature, by enabling Anonymous call feature thereby the receiver won't be able to know who is calling them.

To configure anonymous call via Phone interface

1. Press Menu→ Features→ Anonymous Call→ Profile ID 2 (For example)
2. Press  and  to select the Enable choice in Anonymous Call filed.
3. Press  or Save soft key to save the configuration.

To cancel anonymous call feature via Phone interface



1. Press Menu→ Features→ Anonymous Call→ Profile ID 2 (For example)

2. Press  and  key to select the Disable choice in Anonymous Call filed.
3. Press  or Save soft key to save the configuration.



Reject Anonymous

If you do not want to be disturb by anonymous calls, you can set the reject anonymous call feature, so you will not hear the unknown calls.

To configure rejecting anonymous call

1. Press Menu→ Features→ Anonymous Call→ Profile ID 2 (For example)
2. Press  and  key to select the Enable choice in Rejection filed.
3. Press  or Save soft key to save the configuration.

To cancel rejecting anonymous call



1. Press Menu→ Features→ Anonymous Call→ Profile ID 2 (For example)
2. Press  and  key to select the Disable choice in Rejection filed.
3. Press  or Save soft key to save the configuration.

Call Mute

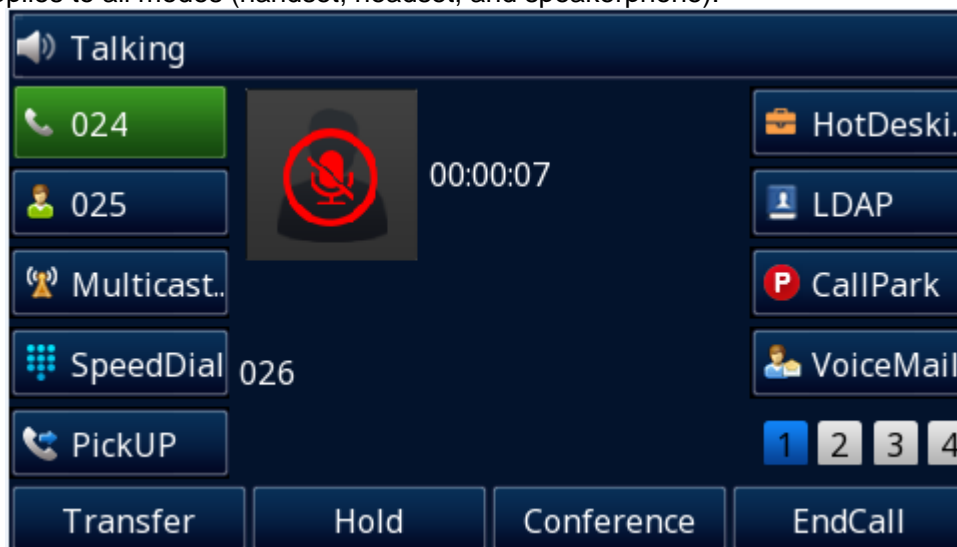
When you use the Mute feature, the other parties will not hear your voice while you can hear their voice. Call mute applies to all modes (handset, headset, and speakerphone).



To mute the call during a call (including a conference call)

1. Press the mute key , the LCD display .
2. To disable the mute function, press  again.

DND

When you use the DND feature, the phone is to reject all incoming calls automatically and you can see the DND icon  shown on the Top of the LCD on idle page.



To enable DND feature via Phone interface:

Press the DND soft key when the phone is idle, and then  is shown on the LCD.

To disable DND feature via Phone interface:

Press the DND soft key again, and then there is no  on the LCD.

Hot Line

To configure Hot Line via Phone interface

1. Press Menu→ Features→ Hot Line
2. Enter the Number and HotLine Delay time (as present, we support off hook auto dial).
3. Press  or Save soft key to save the configuration

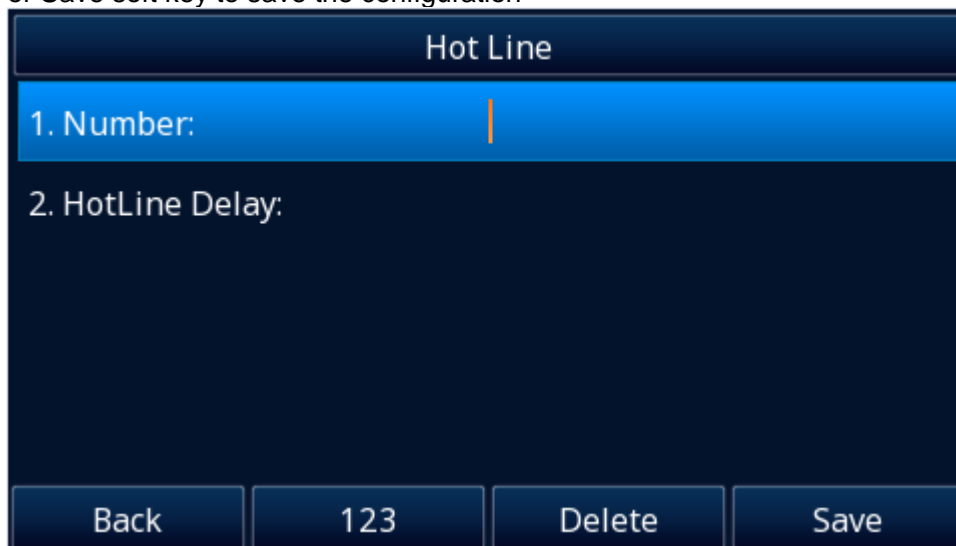

To configure Hotline auto dial via Web interface

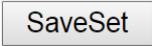
1. Setting→ Features.
2. Fill in the number in the Hotline Number and Hotline Time-out field.
3. Click  to save the configuration.

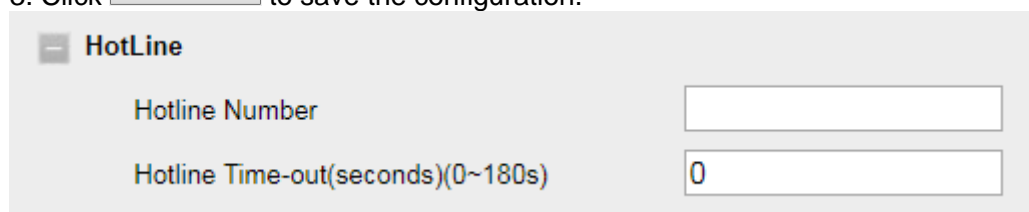

4. Delete the Hotline Number and save the configuration, then now the Hotline auto dial is cancelled.

Auto Redial

After setting this option, if the phone you are calling responds 486 Busy Here, the phone will prompt it with a busy tone (Busy Tone Timer (0~5s)), and then it will prompt Auto Redial, as shown in the figure.

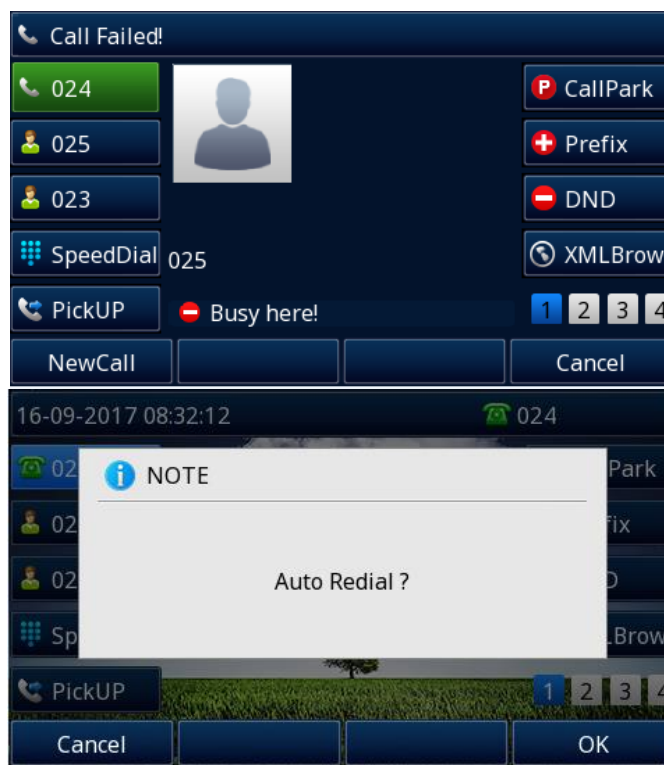

If you press OK, your LCD will prompt Auto Redial Interval and Auto Redial Times.

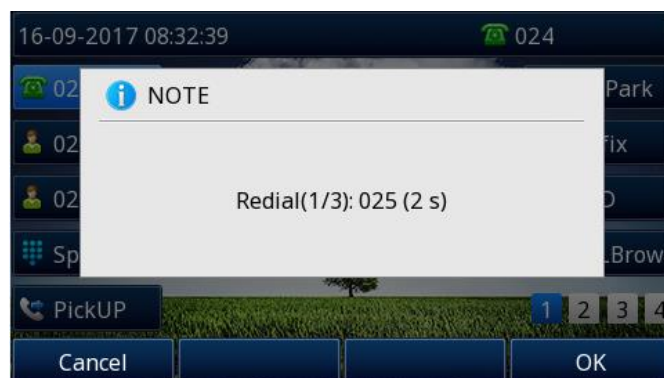

To configure Auto Redial via Web interface

1. Click Setting→ Features→ Auto Redial
2. Select On or Off for the Auto Redial.
3. Fill in the number 1~300 seconds for the Auto Redial Interval.
4. Fill in the number 1~300 times for the Auto Redial Times.
5. Click to save the configuration.

Auto Redial

Auto Redial On Off

Auto Redial Interval (1~300s)

Auto Redial Times (1~300)

Note:

If you do not want the Busy here prompt, please set Busy Tone Timer as 0. 0 means there is no busy tone.

Help center

The help center has two modes: software problem diagnosis and hardware diagnosis. The fault diagnosis mode is used to help technical support engineers collect information (such as phone logs and configurations) more conveniently for technical support and development engineers to analyze customer problems. Hardware diagnosis provides a user-friendly way to diagnose hardware problems.

Software problem diagnosis

To use the help center via Phone interface:

1. Press Menu
2. Press the keypad ##**



3. Press softkey Start
4. Press ok and start operation after the frame disappears
5. Enter the help center again
6. Select stop and the operation logs will be uploaded to the server

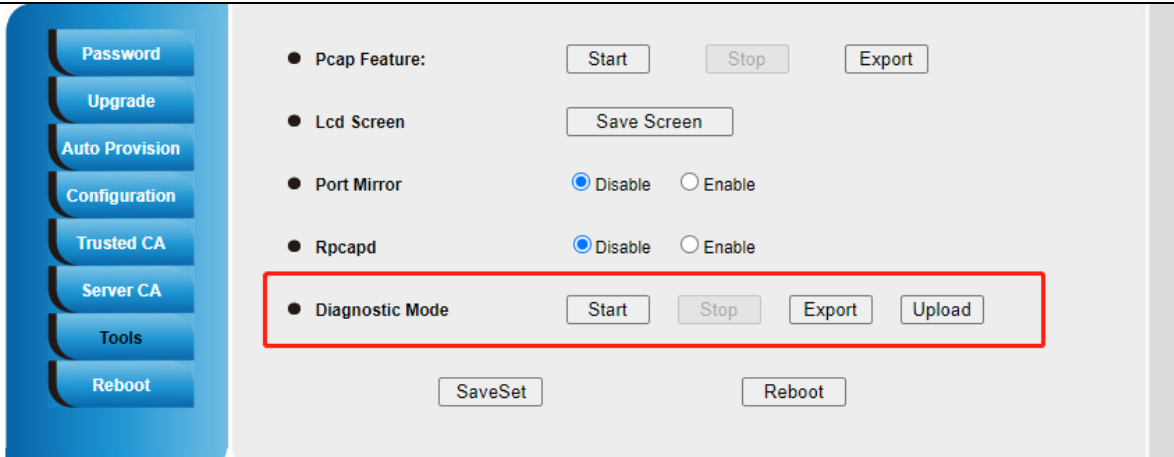

To use the help center via Web interface:

1. Click Management →Tools
2. Click Diagnostic Mode Start
3. Wait for a few seconds and perform the operation on the IP phone
4. Click stop
5. You can choose to export or upload the operation log



Hardware diagnosis

You can perform hardware diagnosis only via Phone interface

1. Press Menu
2. Press the keypad ##**
3. Press  and  to select Hardware diagnostics



Audio Diagnostic:

1. Select Audio Diagnostic
2. The voice chip self-check is automatically performed after the page is displayed
3. Voice echo test Related tests are performed on the phone and you can switch by speakerphone, handset and headset
4. Press finish and choose the result

If you choose abnormal, the phone will play an audio clip:

1. Press start
2. Check whether the sound is normal after playing.
3. If the sound is abnormal, the playback device is faulty; if the sound is normal, the radio device is faulty.

LED Diagnostic:

You can switch the Off, Green and Red states of all LED lights by the left and right keys.

Network Diagnostic:

You can choose WAN Port Status, LAN Port Status, Ping and Trace Route.

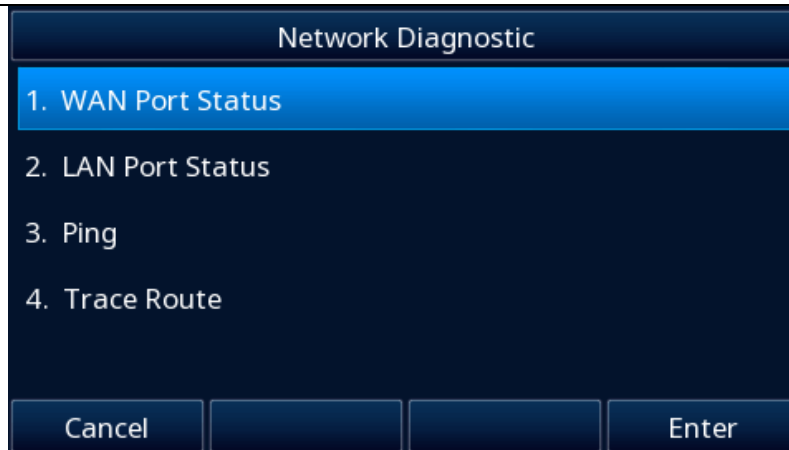

WAN Port Status:

The device checks itself and displays network information

LAN Port Status:

The device checks itself and displays network information

Ping:

The default detection is 8.8.8.8.

Press back and you can enter the IP address

TraceRoute:

The default detection is 8.8.8.8

Press back and you can enter the IP address

USB Diagnostic:

1. The device automatically checks the USB port status
2. Insert the USB as prompted
3. The device will further check whether the function is normal.



Diagnostics



With diagnostics function, you can troubleshoot network connectivity problems. Here you can use both Ping and Traceroute functions. You can enable the phone to detect the reachability of the connected wired or wireless network.

Ping

Ping is used to determine whether the local host can successfully exchange (send and receive) data packets with another host. Based on the returned information, it can be inferred whether the TCP/IP parameters are set correctly, whether the operation is normal, whether the network is smooth, etc.

How to use Ping function:

1. Press soft key Menu→Features

2. Press  and  to choose diagnostics
3. Enter Network→Ping
4. Fill in Ping IP or URL
5. Press soft key Start

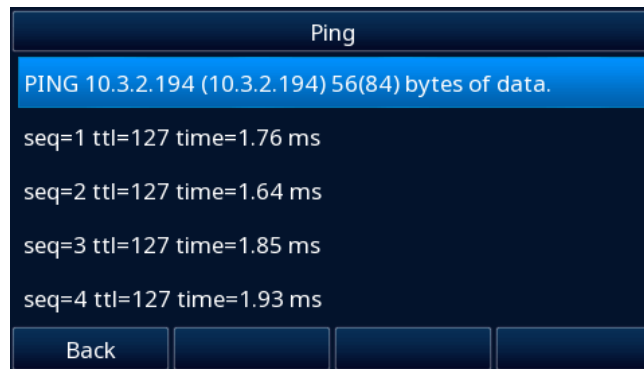

You can also use Ping via the web user interface:

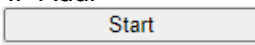

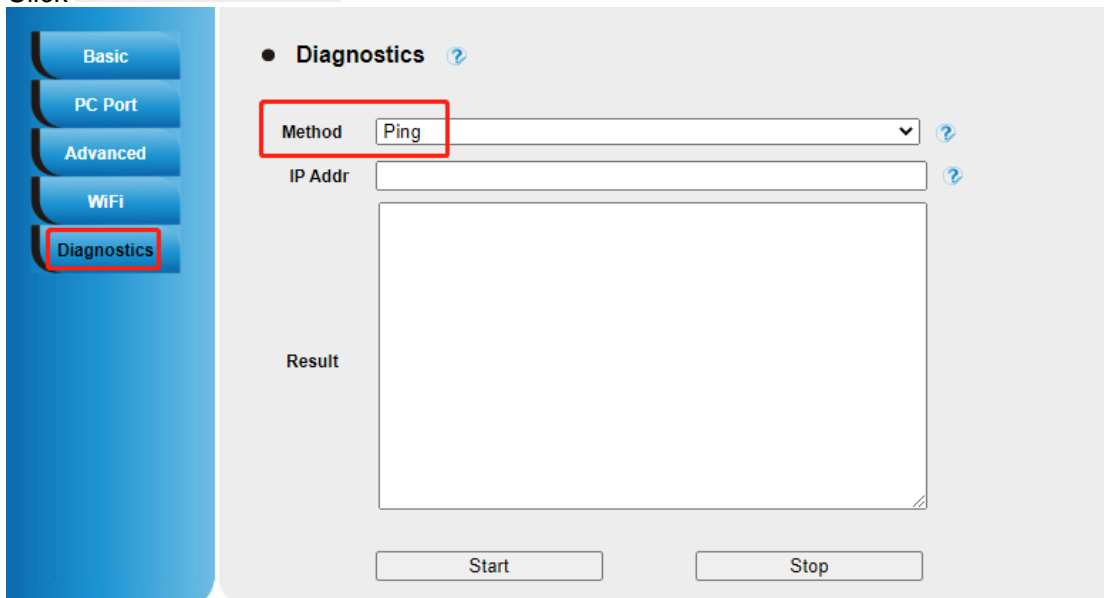
1. Click Network→Diagnostics
2. Choose method Ping
3. Fill in IP Addr
4. Click 



Traceroute

Traceroute measures how long it takes by sending small packets to the destination device until it returns. By default, traceroute tests each device on a path three times. The output results include the time (ms) of each test and the device name (if any) and its IP address.

How to use Traceroute function:

1. Press soft key Menu→Features
2. Press  and  to choose diagnostics
3. Enter Network→Trace Route
4. Fill in Tracert IP or URL
5. Press soft key Start

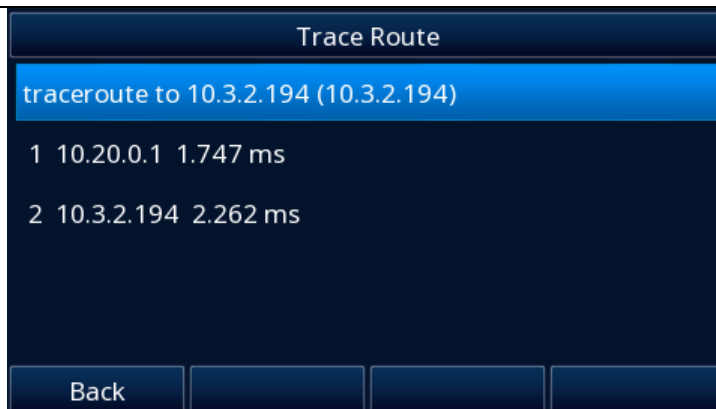

You can also use Traceroute via the web user interface:

1. Click Network→Diagnostics
2. Choose method Traceroute
3. Fill in IP Addr

4. Click and

Power Saving

The power saving feature is used to turn off the backlight to conserve energy. The phone enters power saving mode after it has been idle for a certain period of time. Image persistence may be caused on LCD if Power Saving is disabled.

Office Hour: The period of time you use the phone frequently. Time from 0 o'clock to 23 o'clock.

Idle Timeout: specify the period of time before the IP phone enters the power-saving mode.

You can specify the following three types of idle timeout

Office Hour Idle TimeOut: It's the time of phone waits in the idle state before the phone enters power saving mode during the office hours. (Integer from 1 to 960 minutes)

Off Hour Idle TimeOut: It's the time of phone waits in the idle state before the phone enters power saving mode during the non-office hours. (Integer from 1 to 10 minutes)

User Input Extension Idle TimeOut: It's the minimum time of phone waits in the idle state after using the phone before the phone enters power saving mode. (Integer from 1 to 30 minutes)

How to config your Power Saving mode:

You can enable or disable power saving and set the different idle timeout in the web user interface.

1. Click Setting→Power Saving
2. Click Enable
3. Fill in the Office Hour and Idle and Idle TimeOut Setting
4. Click

Preference
Features
BLF Settings
Line Settings
Date&Time
Tones
Voice
SMS
Action URL
Softkey layout
TR069
SIP
Power Saving

Power Saving Disable Enable

Office Hour ?

Monday	7	--	19
Tuesday	7	--	19
Wednesday	7	--	19
Thursday	7	--	19
Friday	7	--	19
Saturday	7	--	7
Sunday	7	--	7

Idle TimeOut Settings(minutes)

Office Hour Idle TimeOut	960	?
Off Hour Idle TimeOut	10	?
User Input Extension Idle TimeOut	10	?

SaveSet
Cancel

Advanced Call Features

Call Pickup

With this feature, you can answer incoming calls someone else received.



To configure Direct Pickup code via Web interface



1. Click Account→ Basic.
2. Select the desired account from the pull-down list of Account in the Account field.
3. Fill in the Direct Call Pickup Code.
4. Click SaveSet to save the configuration.

Direct Call Pickup Code

To configure Direct Pickup feature via Phone interface

1. Press Menu→ Features→ Function Keys→ Line Keys as Function Keys→ Line Key2(for example)

2. Press  and  key to select the DPickup in the Type field.
3. Enter the targeted Number in the Value field.

4. Press  and  key to select the Account ID.

5. Press  or Save soft key to save the configuration, then the selected Line Key will work as Direct Pickup.

To configure Direct Pickup feature via Web interface

1. Click Function Keys→ Line Key.
2. Select the wanted Line Key and set as Direct Pickup.
3. Enter the desired phone number in the Value field.
4. Select the Account
5. Click SaveSet to save the configuration.

Line	Type	Mode	Value	Label	Account	Extension
Key1	Line	Default			Account 1	
Key2	Direct Pickup	Default	*20*137		Account 1	

Group Pickup





With this feature, you can pick up the specified group that you want incoming calls.

To configure Group Pickup code via Web interface

1. Click Account→ Basic.
2. Select the desired account from the pull-down list of Account in the Account field.
3. Fill in the Group Call Pickup Code
4. Click to save the configuration.

Group Call Pickup Code

To configure the Group Pickup via Phone interface

1. Press Menu→ Features→ Function Keys→ Line Keys as Function Keys→ Line Key2(for example)
2. Press  and  key to select the GroupPickup in the Type field.
3. Enter the targeted Number in the Value field.
4. Press  and  key to select the Account ID.
5. Press  or Save soft key to save the configuration

To configure the Group Pickup via Web interface





1. Click Function Keys→ Line Key.
2. Select the desired Line Key and select Group Pickup in the Type field.
3. Enter the desired phone number in the Value field.
4. Select the Account
5. Click to save the configuration.

Line	Type	Mode	Value	Label	Account	Extension
Key1	Line	Default		243	Account 1	
Key2	Group Pickup	Default	8038		Account 2	

Call Park

With this feature, you can put a call on hold and continue the conversation from another phone.

To configure the Call Park via Phone interface

1. Press Menu→ Features→ Function Keys→ Line Keys as Function Keys→ Line Key2(for example)
2. Press  and  or press Switch soft key to select the Call Park in the Type field.
3. Enter the call park code in the Value field
4. Press  and  key to select the Account ID.
5. Press  or Save soft key to save the configuration.

To configure the Call Park via Web interface

1. Click Function Keys→ Line Key.

2. Select the desired Line Key and select Call Park in the Type field.
3. Enter the call park code in the Value field.
4. Select the Account.
5. Click the button to save the configuration.

Line	Type	Mode	Value	Label	Account	Extension
Key1	Line	Default		088	Auto	
Key2	Call Park	Default	SP10		Account 1	



Busy Lamp Field (BLF)



You can use the BLF (Busy Lamp Field) feature to monitor a specific extension number whether the extension is busy or free.

1. When the extension you are monitoring is idle, the light is steady green.
2. When the monitored extension is ringing, the light is blinking red, press the BLF key to pick the phone up directly.
3. When the monitored extension is calling or in a conversation, the light is steady red.

To configure a BLF key via Phone interface

1. Press Menu→ Features→ Function Keys→ Line Keys as Function Keys→ Line Key2(for example).

2. Press  and  key to select the BLF in the Type field.
3. Enter the targeted Number in the Value field.

4. Press  and  key to select the Account ID.
5. Enter the Pickup Code.

6. Press  or Save soft key to save the configuration

To configure a BLF key via Web interface

1. Click Function Keys→ Line Key.
2. Select the desired Line Key and select BLF in the Type field.
3. Enter the monitored phone number in the Value field.
4. Select the Account
5. Fill in the Extension.
6. Click to save the configuration.

Line	Type	Mode	Value	Label	Account	Extension
Key1	Line	Default		243	Account 1	
Key2	BLF	Default	245		Account 1	

Note:

This feature is not available on all servers. For more information, contact your system administrator.

After setting the BLF key, do not need to restart the phone.

Visual Alert for BLF Pickup

If this option is on, when you use the BLF feature to monitor a specific phone whether it is busy or free, you can see this message on the LCD, as shown in the following figure.

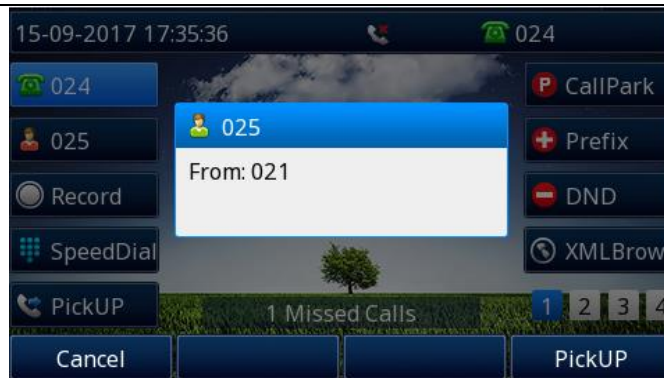

To configure Visual Alert for BLF Pickup via Web interface

1. Click Setting→ Features→ Call Pickup→ Visual Alert for BLF Pickup
2. Select Enable or Disable for Visual Alert for BLF Pickup.
3. Click to save the configuration.

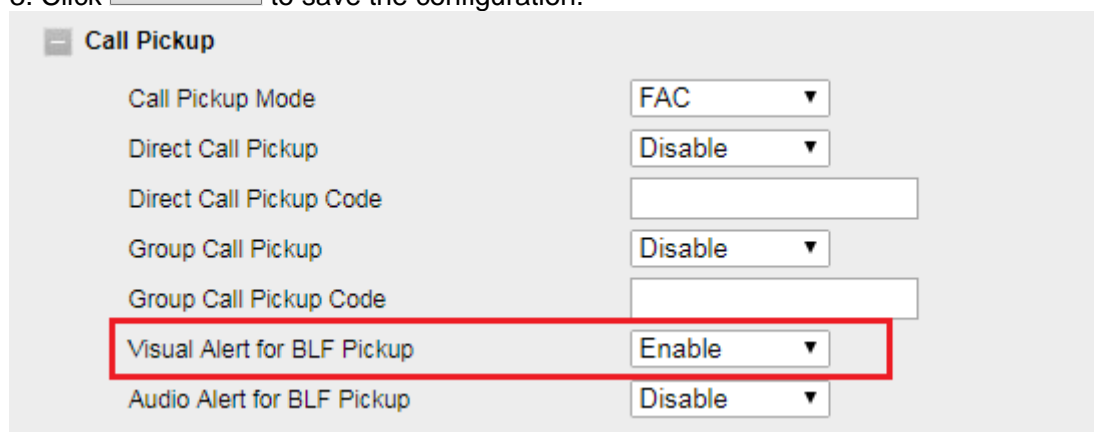

To configure BLF via Web interface

1. Click Function Keys→ Line key
2. Select the desired Line.
3. Type selection as BLF.
4. Fill in the required BLF value.
5. Fill in the required pickup code for the extension number.
6. Click to save the configuration.

Line	Type	Mode	Value	Label	Account	Extension
Key1	Line	Default			Account 2	
Key2	BLF	Default	1025		Account 2	*04

Audio Alert for BLF Pickup

If this option is on, when you use the BLF feature to monitor a specific phone whether it is busy or free, you can hear beep.

To configure Audio Alert for BLF Pickup via Web interface

1. Click Setting→ Features→ Call Pickup→ Audio Alert for BLF Pickup
2. Select Enable or Disable for Audio Alert for BLF Pickup.
3. Click to save the configuration.

Call Pickup

Call Pickup Mode: FAC

Direct Call Pickup: Disable

Direct Call Pickup Code:

Group Call Pickup: Disable

Group Call Pickup Code:

Visual Alert for BLF Pickup: Disable

Audio Alert for BLF Pickup: Enable

BLF List

To configure BLF List via Web interface:

1. Login and click Account→ Basic
2. Select the desired account from the pull-down list of Account in the Account field.
3. Fill in the Eventlist BLF URL.

Eventlist BLF URL:

4. Click Profile→ Advanced
5. Select the desired profile from the pull-down list of Profile in the Profile field.
6. Select the SIP Server Type

SIP Server Type: BroadSoft

7. Click **SaveSet** to save the configuration.
8. To configure BLF List Keys
 - 8.1 Click Function Keys→ Line Key
 - 8.2 Select the desired Line Key and select the BLF List in the Type field.
 - 8.3 Select the Account
 - 8.4 Click **SaveSet** to save the configuration.

Line	Type	Mode	Value	Label	Account	Extension
Key1	Line	Default	<input type="text"/>	243	Account 1	<input type="text"/>
Key2	BLF List	Default	<input type="text"/>	<input type="text"/>	Account 1	<input type="text"/>

Share Line

Htek IP Phone supports “Shared Call Appearance” by Broadsoft and XCast standard. This feature allows members of the SCA group to shared SIP lines and provides status monitoring (idle, active, progressing, hold) of the shared line. When there is an incoming call designated for the SCA group, all of the members of the group will be notified of an incoming call and will be able to answer the call from the phone with the SCA extension registered in the group.

All the users that belong to the same SCA group will be notified by visual indicator when a user seizes the line and places an outgoing call, and all the users of this group will not be able to seize the line until the line goes back to an idle state or when the call is placed on hold (with the exception of when multiple call appearances are enabled on the server side).

In the middle of the conversation, there are two types of hold: Public Hold and Private Hold. When a member of the group places the call on public hold, the other users of the SCA group will be notified of

this by the red-flashing button and they will be able to resume the call from their phone by pressing the line button. However, if this call is placed on private-hold, no other member of the SCA group will be able to resume that call.

To enable shared call appearance, the user would need to register the shared line account on the phone. In addition, they would need to navigate to “Account” → “Basic” and “Profile” → “Advanced” on the webpage and set the line to “Shared Line” and “SIP Server Type”, and configure the line key or Line Key as “Line” type with the desired account on webpage or LCD. If the user requires more shared call appearances, the user can configure multiple line keys (Function Keys→ Line Key) to be “Line” type associated with the account.

This feature is very useful in the boss and secretary scenario. For example, the secretary can share the boss' extension number on her phone. When there is an incoming call to the extension number of the boss, both the phones of the boss and the secretary will ring simultaneously. Either the boss or the secretary can answer the call. Calls on shared line can be placed on hold or barged in.

To enable share line via Web interface

1. Click Account→ Basic
2. Select the desired account from the pull-down list of Account in the Account field.
3. Select SCA for the Shared Line.

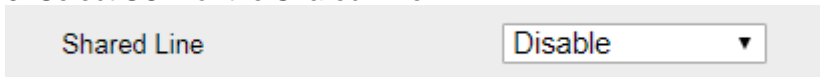

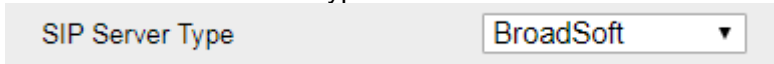

4. Click Profile→ Advanced
5. Select the desired profile from the pull-down list of Profile in the Profile field.
6. Select the SIP Server Type.

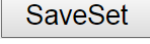

7. Click  to save the configuration.

To configure Line key via Phone interface

1. Press Menu→ Features→ Function Keys→ Line keys as Function Keys→ Line Key1(for example)
 2. Press  and  key to select the Line in the Type field.
 3. Select the Account ID.
 4. Press  or Save soft key to save the configuration.
- Then the selected Line Key will work as Line.

To configure Line key via Web interface

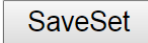
1. Click Function Keys→ Line Key.
2. Select the wanted Line Key and set as Line.
3. Select the Account.
4. Click the  button to save the configuration.

Line	Type	Mode	Value	Label	Account	Extension
Key1	Line	Default		243	Account 1	
Key2	N/A	Default			Account 1	

Note:



This feature is not available on all servers. For more information, contact your system administrator.

Intercom

When use the intercom feature, you can quickly get access connect to the configured one.

To configure Intercom feature via Phone interface

1. Press Menu→ Features→ Function Keys→ Line Keys as Function Keys→ Line Key2(for example)

2. Press  and  key to select the Intercom in the Type field.
3. Enter the intercom codes followed by desired number.
4. Select the Account ID.
5. Press  or Save soft key to save the configuration. Then the selected Line Key will work as Intercom.

To configure Intercom feature via Web interface

1. Click Function Keys→ Line Key.
2. Select the wanted Line Key and set as Intercom.
3. Enter the intercom codes followed by desired number in the Value field.
4. Select the Account.
5. Click the  button to save the configuration.

Line	Type	Mode	Value	Label	Account	Extension
Key1	Line	Default		088	Auto	
Key2	Intercom	Default	*11012		Account 1	

If you want to achieve the Intercom feature, you must enable the “Allow Auto Answer by Call-Info”

1. Login webpage, and click Profile→ Advanced
2. Select the desired profile from the pull-down list of Profile in the Profile field.
3. Select Yes for the “Allow Auto Answer By Call-Info”
4. Click the  button to save the configuration.

Allow Auto Answer By Call-Info No Yes

Note:

This feature is not available on all servers. For more information, contact your system administrator.

Intercom Barge

If this option is enabled, when there is an active call and an incoming intercom call arrives, the previous call will be put on hold and the intercom call will be answered.

1. Login webpage, and click Setting→ Preference
2. Set On or Off for Intercom Barge.
3. Click  for the setting.

Intercom Barge On Off 

Note:

This feature is not available on all servers. For more information, contact your system administrator.

Short Message Service (SMS)

Send SMS

To send SMS via Web interface

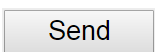
1. Click Setting→ SMS
2. Select the Account (from which account the SMS sent)
3. Enter the target Number
4. Input the content of SMS and click .

Account

Number



Message

To send SMS via Phone interface:

1. Click Menu→ Messages→ SMS→ Set SMS
2. Enter the contents in the white field.
3. Press the Send button.
4. Select the account in the From field (from which account the SMS sent)
5. Enter the target number in the To field (to which account the number sent)
6. Press the Send button.

Set SMS Line Key

To configure the SMS via Phone interface

1. Press Menu→ Features→ Function Keys→ Line Keys as Function Keys→ Line Key2(for example)
2. Press  and  key to select the SMS in the Type field.
3. Press  or Save soft key to save the configuration.

To configure the SMS via Web interface

1. Click Function Keys→ Line Key.
2. Select the desired Line Key and select SMS in the Type field.
3. Click to save the configuration.

Line	Type	Mode	Value	Label	Account	Extension
Key1	Line	Default		243	Account 1	
Key2	SMS	Default			Account 1	

Voice Mail

This phone supports voicemail, and when there is a message, you can press the message key  to listen to voice Mail. Text Notify will be displayed on the LCD of the phone.



To configure the Voice Mail feature via Phone interface:

1. Press Menu→ Messages→ Voice Mail→ Set Voice Mail.
2. Enter the Account No.
3. Press or Save soft key to save the configuration.

To configure the Voice Mail feature via Web interface:

1. Click Account→ Basic.
2. Select the desired account from the pull-down list of Account in the Account field.
3. Fill in the Voice Mail UserID.
4. Click to save the configuration.

Voice Mail UserID

To configure a Voice Mail key via Phone interface:

1. Press Menu→ Features→ Function Keys→ Line Keys as Function Keys→ Line Key2(for example).
2. Press and key to select the Voice Mail in the Type field.
3. Enter the targeted feature codes in the Value field.
4. Press and key to select the Account ID.
5. Press or Save soft key to save the configuration.

To configure a Voice Mail Key via Web interface:

1. Click Function Keys→ Line Key.
2. Select the wanted Line Key and set as Voice Mail.
3. Enter the desired voicemail feature codes in the Value field.
4. Select the Account.
5. Click to save the configuration.

Line	Type	Mode	Value	Label	Account	Extension
Key1	Line	Default		243	Account 1	
Key2	Voice Mail	Default	*97		Account 1	

To leave a voice mail:

You can leave a voice mail when the receiver is busy or its inconvenient for them to answer the call. Follow the voice prompt from the system server to leave a voice mail, and then hang up.

To listen to voice mails:

When the phone interface prompts receiving new voice mail icon, the power indicator LED work(Settings→ Features→ LED Status Setting: Voice Message Status: Yes) and the voice message button flashes green.

1. Pressing  or the targeted Line Key to dial out the voice mail access code.
2. Follow the voice prompt to listen to voice mail.

To view the voicemail via Phone interface:

Press Menu→ Messages→ Voice Mail→ View Voice Mail.

The LCD screen displays the amount of new and old voice mails.

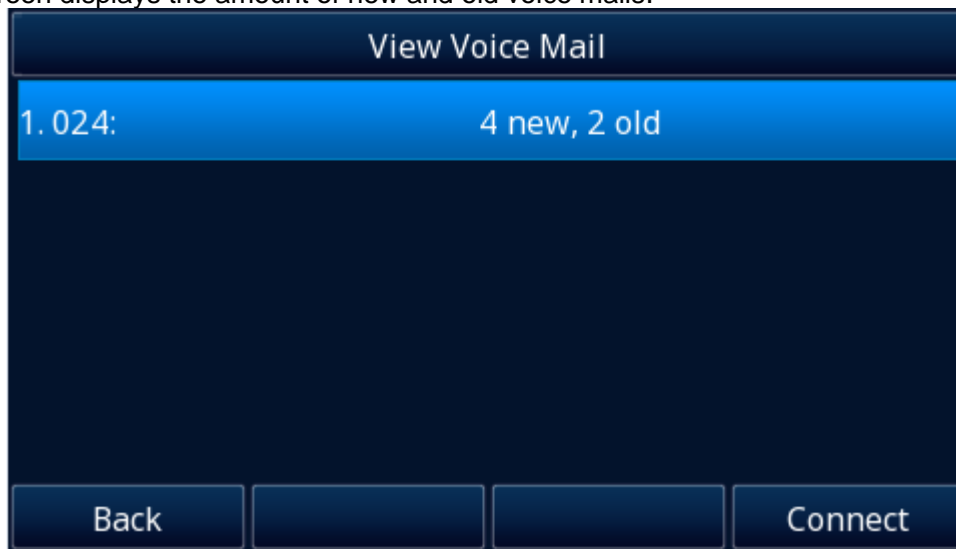

Note:

1. This feature is not available on all servers. For more information, contact your system administrator.
2. Before listening to voice mails, make sure the voice mail access code has been configured.
3. When all new voice mails are retrieved, the power indicator LED, voice mail indicator LED and targeted Line Key LED will go out.

Using the Hot Desking



Hot Desking

Hot Desking originates from the definition of being the temporary physical occupant of a workstation or surface by a particular employee. A primary motivation for Hot Desking is cost reduction. This feature is regularly used in places where all employees are not in the office at the same time, or not in the office for a very long time, which means their personal offices are often vacant, consuming valuable space and resources.

You can use Hot Desking on the IP phone to logout the existing accounts and then log in a new account, which allows many users to share the phone resource in different times. To use this feature, first you need to configure a Hot Desking key in the advance settings.

This feature is supported on the version 1.0.3.82 or later.

To configure the Hot Desking via Phone interface

1. Press Menu→ Features→ Function Keys→ Line Keys as Function Keys→ Line Key2(for example)
2. Press  and  key to select the Hot Desking in the Type field.

3. Press  or Save soft key to save the configuration.

To configure the Hot Desking via Web interface:

1. Click Function Keys→ Line Key.
2. Select the desired Line Key and select Hot Desking in the Type field.
3. Click the  button to save the configuration.

Line	Type	Mode	Value	Label	Account	Extension
Key1	Line	Default		243	Account 1	
Key2	Hot Desking	Default			Account 1	

To use the Hot Desking feature on the user interface:

1. Press the Hot Desking key when the IP Phone is idle.
 2. "Clear all other account config?" is shown on the screen and press OK.
 2. Enter the Extension number and password
 3. Click Save soft key
- You can see the account information which has changed.



Note:

This feature is not available on all servers. For more information, contact your system administrator.

Automatic Call Distribution (ACD)

ACD feature is often used in offices for customer service, such as call center. The ACD system handles large volumes of incoming calls from callers who have no need to talk to a specific person but who require assistance from any of the different personnel at the earliest point. The ACD feature on the Htek IP Phone allows the ACD system to distribute calls from large volumes of incoming calls to the registered IP phone users. To use this feature, first you should configure an ACD key in the advance settings.

To configure the ACD via Phone interface

1. Press Menu→ Features→ Function Keys→ Line Keys as Function Keys→ Line Key2(for example)
2. Press  and  key to select the ACD in the Type field.
3. Select the desired account in the Account ID field.
4. Press  or Save soft key to save the configuration.

To configure the ACD via Web interface:

1. Click Function Keys→ Line Key.
2. Select the desired Line Key and select ACD in the Type field.
3. Select the desired account from the pull-down list of Account field.
4. Click the  button to save the configuration.

Line	Type	Mode	Value	Label	Account	Extension
Key1	Line	Default		243	Account 1	
Key2	ACD	Default			Account 1	

Note:

This feature is not available on all servers. For more information, contact your system administrator.

This section provides the operating instructions for managing contacts. The topics include:

- Local Directory
- Remote Phonebook
- LDAP
- Search Contact

Local Directory

In the directory, you can add or delete your friends, business partner or anyone others' phone No., so you will not forget their number. Or put some anonymous phone No. in the blacklist to prevent from being disturbed. The local Directory can add up to 10000 contacts.

Contact Groups

Adding Contact Groups

To organize your contacts and make them easier to find, you can add additional groups in the Local Directory.

To Add Contact Group in the Local Contacts

1. Select Directory or navigate to Menu -> Directory -> Local Contacts.
2. Press the Add softkey.
3. Enter the desired group name.
4. Select the desired Ring Tone.

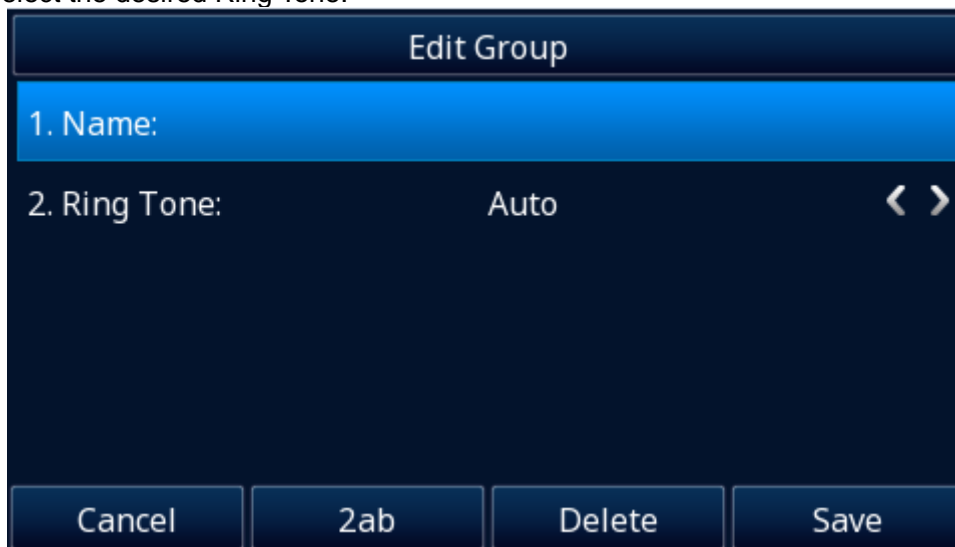

5. Press the Save softkey or press  to save the configuration.



Editing Contact Groups

You can change or add the group's information.

To edit Contact Group in the Local directory

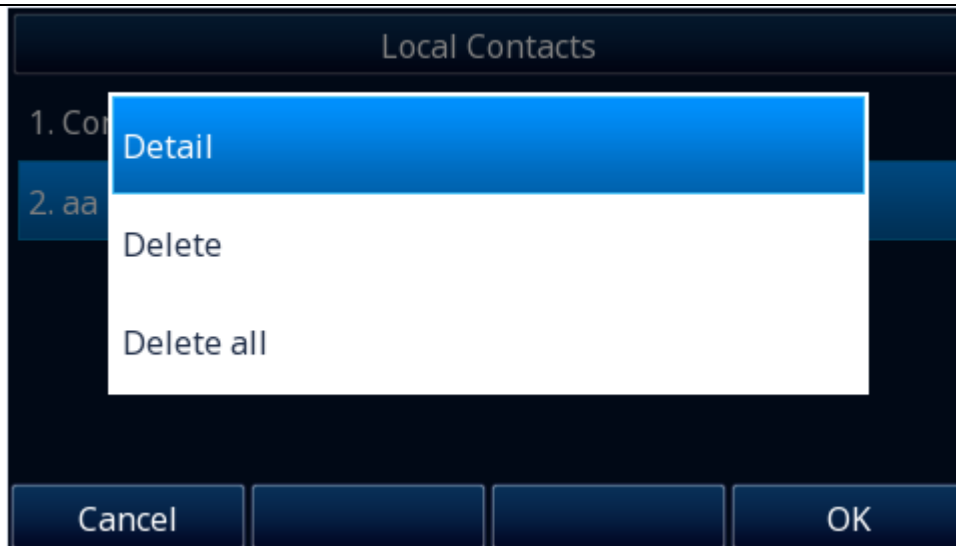
1. Select Directory or navigate to Menu -> Directory -> Local Contacts.
2. Select a group (The default Contacts group cannot be edited).
3. Press the Option soft key.



4. Select the Detail and press OK soft key or press .
5. Edit the group information.
6. Press the Save softkey or press  to save the configuration.

Deleting Contact Groups

When deleting a contact group, the Contacts group will not be deleted.

To delete Contact Group in the Local directory

1. Select Directory or navigate to Menu -> Directory -> Local Contacts.
2. Select a group (The default Contacts group cannot be edited).
3. Press the Option soft key.
4. Select the Delete and press OK soft key or press .

Managing the Local Directory Contacts

You can manage the Local Directory contacts when the phone is idle.

Adding Contacts

After adding a contact to the local directory, you can choose to enter relevant information for the contact. At a minimum, you need to enter the contact's name for each new contact.





To Adding Contacts via Phone interface

1. Select Directory or navigate to Menu -> Directory -> Local Contacts.
2. Select the desired contact group or Contacts.
3. Press Add soft key.
4. Enter your contact's information, name (Name cannot be empty).



5. Press the Save softkey or press  to save the configuration.

To add contacts from history via Phone interface:

1. Press History soft key or press Menu→ History→ All/ Missed/ Received/ Dialed/ Forwarded Calls
2. Press  and  to select the targeted one. (Press  and  switched among the All Calls, Missed Calls, Received Calls, Dialed Calls and Forwarded Calls).
3. Press Option soft key→ Add to Contacts
4. Edit the necessary information as Name, Phone number...
5. Press Save soft key or  to add the contacts successfully.

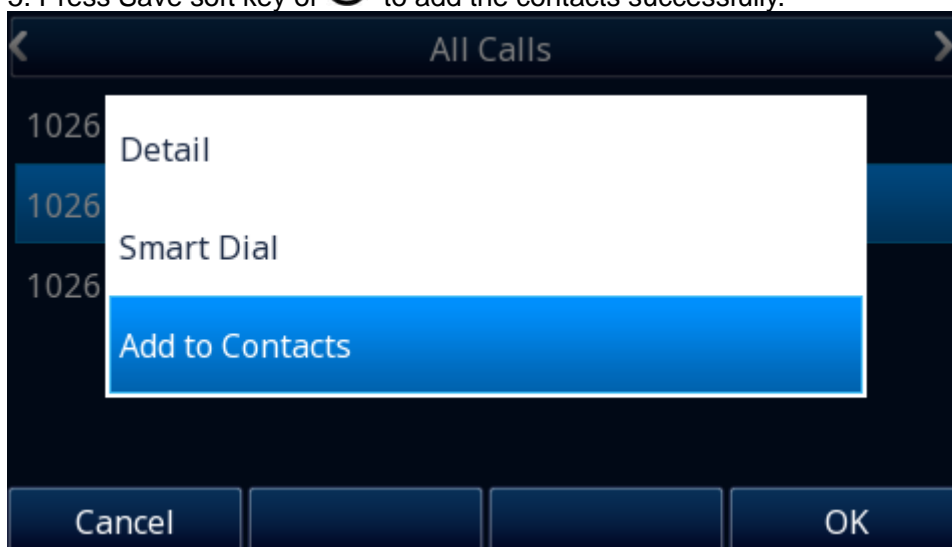

To add contacts via Web interface:

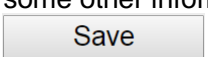
1. Click Directory→ Directory
2. Enter the name, number and some other information.
3. Press  and then press  button.

Contact
BlackList

Index	Display Name	Office Number	Mobile Number	Other Number	Account
1	tom	028			Auto

Hangup
Save
Delete
Move to Contact/blacklist

Contact

Name

Office Number

Mobile Number

Other Number

Account

Ring

Group

Photo

Add
Edit
Search



Delete Photo

Browse... No file selected.

Upload Photo

Import Local Contacts

Browse... No file selected.

Viewing Contacts



To view Contacts in the Local Contacts:

1. Select Directory or navigate to Menu -> Directory -> Local Contacts.
2. Select the desired contact group or Contacts.
3. Press Enter soft key or press .

Editing Contacts

You can update your contacts' information.

To edit Contacts in the Local Contacts:



1. Select Directory or navigate to Menu -> Directory -> Local Contacts.
2. Select the desired contact group or Contacts.
3. Press Enter soft key or press .
4. Press the Option soft key.
5. Select the "Detail" option and press the OK or .
6. Edit the contact information (Name, Number).
7. Press the Save softkey or press  to save the configuration.

Deleting a Contact

You can delete any contact from the Local Contacts.

To delete Contacts in the Local Contacts:



1. Select Directory or navigate to Menu -> Directory -> Local Contacts.
2. Select the desired contact group or Contacts.

3. Press Enter soft key or press .
4. Press the Option soft key.
5. Select the “Delete” option and press the OK or .
6. And prompt “Are you sure to delete this item?”.
7. Press OK soft key or .

Deleting All Contacts

You can delete all contacts from the Local Directory.





To delete all Contacts in the Local Contacts:

1. Select Directory or navigate to Menu -> Directory -> Local Contacts.
2. Select the desired contact group or Contacts.
3. Press Enter soft key or press .
4. Press the Option soft key.
5. Select the “Delete” option and press the OK or .
6. And prompt “Are you sure to delete this item?”.
7. Press OK soft key or .

Moving a Local Directory Contact to Blacklist

You can move a contact in the Local Directory to blacklist. Incoming calls from this contact will be rejected automatically.

To move a local Contact to Blacklist:

1. Select Directory or navigate to Menu -> Directory -> Local Contacts.
2. Select the desired contact group or Contacts.
3. Press Enter soft key or press .
4. Press the Option soft key.
5. Press  and  and select the “Add to Blacklist” option and press the OK or .
6. And prompt “Move item to Blacklist, Are you sure?”.
7. Press OK soft key or .

Searching for Contacts

In the Local Directory, you can enter search criteria to find your desired contact quickly.

To search contacts in the local contacts:

1. Select Directory or navigate to Menu -> Directory -> Local Contacts.
2. Press Search soft key, Enter your search criteria in the search field.

Upload Contacts photo

Upload Contacts photo via Web interface:

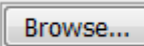
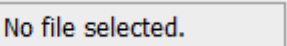
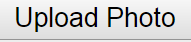
1. Click Directory → Directory and select the desired contact.
2. Click   to select the photo for the contact.
3. Click  to upload the photo.

Contact BlackList

Index	Display Name	Office Number	Mobile Number	Other Number	Account	<input type="checkbox"/>
1	Alice	026			Auto	<input type="checkbox"/>

Hangup Save Delete Move to Contact/blacklist

Contact

Name

Office Number

Mobile Number

Other Number

Account Auto

Ring Default

Group All

Photo Auto

Group Info

Group

Ring Auto



No file chosen

Import Local Contacts

No file chosen

No file chosen

Show Title

When you place a call from the contact, the phone idle screen will show the contact photo.

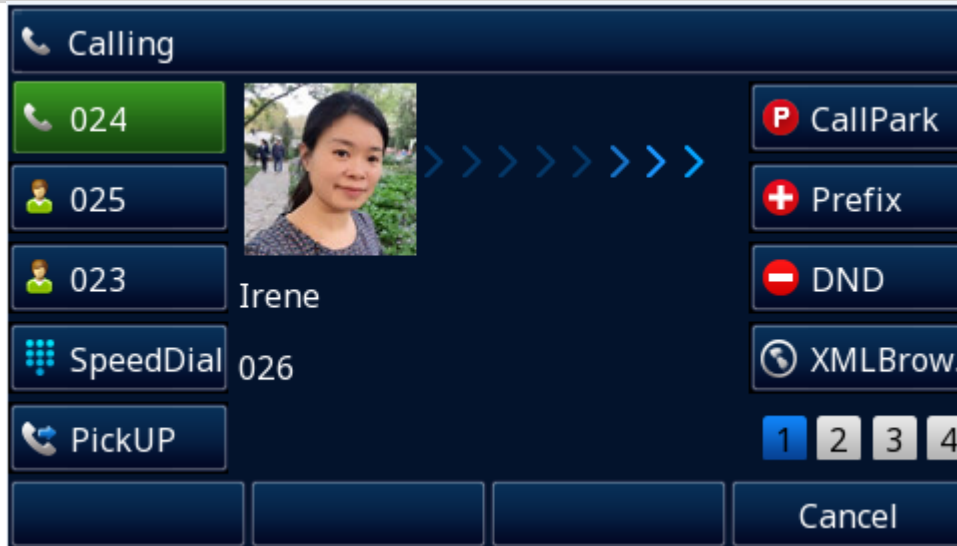

Note:

The size of each photo file cannot exceed 10KB, and the size does not exceed 100x100 pixels.

Contacts photo server

The user can obtain the latest photo of the corresponding account contact through the server. First, click Setting→ Preference, and fill in the Contacts Photo Server path (e.g. <http://192.168.1.18/photo/>). Maximum length of contact photo server parameter 255.

Contacts Photo Server

<http://192.168.1.18/photo/>

Then, place the photo files in the server folder, the file name format is "XXX.jpg", "XXX" is the extension number of the corresponding contact.

When the phone is on a call, the corresponding photos will be obtained from the server for display.

```
<?xml version="1.0" encoding="UTF-8"?>
<contactData>
  <group>
    <contact sDisplayName="075" sOfficeNumber="075" sMobilNumber="" sOtherNumber="" sAccountIndex="255" sRing="Auto" group="" photoDefault="Config:gee.jpg" photoSelect="0" />
    <contact sDisplayName="076" sOfficeNumber="076" sMobilNumber="" sOtherNumber="" sAccountIndex="255" sRing="Auto" group="" photoDefault="Config:htek.jpg" photoSelect="0" />
  </group>
  <blacklist>
  </blacklist>
  <groupinfo>
  </groupinfo>
</contactData>
```

Note:

- 1.If the photo of the corresponding contact in the phone book has been configured through the web page, it will be used first instead of the photo on the server.
- 2.The size of each photo file on the server cannot exceed 10KB.

To import or export the contact list

You can manage your phone's local directory via phone or web user interface. But you can only import or export the contact list via Web interface.

To import an XML file of contact list via Web interface:

1. Click on Directory→ Directory
2. Click **Choose File** to select a contact list file (file format must be .xml) from your local system.
3. Click **Import XML** to import the contact list.

To export an XML file of contact list via Web interface:

1. Click on Directory→ Directory
2. Click **Export XML** to export the contact list.

To import a CSV file of contact list via Web interface:

1. Click on Directory→ Directory
2. Click **Choose File** to select a contact list file (file format must be .csv) from your local system.
3. Click **Import Csv** to import the contact list.

To export a CSV file of contact list via Web interface:

1. Click on Directory→ Directory
2. Click **Export Csv** to export the contact list.

Contact

Name

Office Number

Mobile Number

Other Number

Account

Ring

Group

Photo

Group Info

Group

Ring

No file chosen

Import Local Contacts

No file chosen

No file chosen

Show Title

Note:

If the XML file or CSV file has more than 10000 contacts, the phone will only upload 10000 contacts.

Blacklist

Incoming calls from the Blacklist are rejected automatically.

Adding a Blacklist Contact

You can add a blacklist contact on the phone to prevent someone from calling you.

To add a blacklist contact via phone interface:

1. Select Directory or navigate to Menu -> Directory -> Blacklist.
2. Select Add soft key.
3. Enter the desired value (Name, Number...)
4. Press the Save button to save the configuration.

To add a blacklist contact via web interface:

1. Click the webpage->Directory->Directory -> BlackList
2. Fill in the desired value in the contact (Name, Number).
3. Click the Add button and save the configuration.

Viewing Blacklist Contacts

You can view the blacklist contacts from the Blacklist on your phone.

To view blacklist contact via phone interface:

1. Select Directory or navigate to Menu -> Directory -> Blacklist.

Editing a Blacklist Contact

You can update your blacklist contacts' information.

To edit a blacklist contact via phone interface:

1. Select Directory or navigate to Menu -> Directory -> Blacklist.
2. Press the Option soft key and select the Detail.
3. Modify the desired value (Name, Number...)
4. Press the Save button to save the configuration.

Deleting Blacklist Contacts

You can delete one or all blacklist contacts. If a contact is removed from the blacklist, you can answer the call from the contact normally.

Deleting a Blacklist Contact

If you want to answer a call from a specific contact, you need to remove it from the Blacklist.

To delete blacklist contact via phone interface:

1. Select Directory or navigate to Menu -> Directory -> Blacklist.
2. Press the Option soft key and select the Delete.
3. Press the OK soft key and a pop-up box "Are you sure to delete this item?".
4. Press OK soft key to confirm deletion.

Deleting All Blacklist Contacts

You can delete all contacts from the Blacklist when you are ready to answer calls from them again.

To delete all blacklist contact via phone interface:

1. Select Directory or navigate to Menu -> Directory -> Blacklist.
2. Press the Option soft key and select the Delete All.
3. Press the OK soft key and a pop-up box "Are you sure to delete this item?".
4. Press OK soft key to confirm deletion.

Moving a Blacklist Contact to the Local Directory

You can move a blacklist contact to a Local Directory. Incoming calls from this contact will not be rejected automatically.

To move a blacklist contact to the Local Directory via phone interface:

1. Select Directory or navigate to Menu -> Directory -> Blacklist.

2. Press the Option soft key and select the Add to Contacts.
3. Press the OK soft key and a pop-up box "Move item to contacts, Are you sure?".
4. Press OK soft key.

To move a blacklist contact to the Local Directory via web interface:

1. Click the webpage->Directory->Directory -> BlackList
2. Select the contact you want to remove.
3. Click the Move to Contact/blacklist.

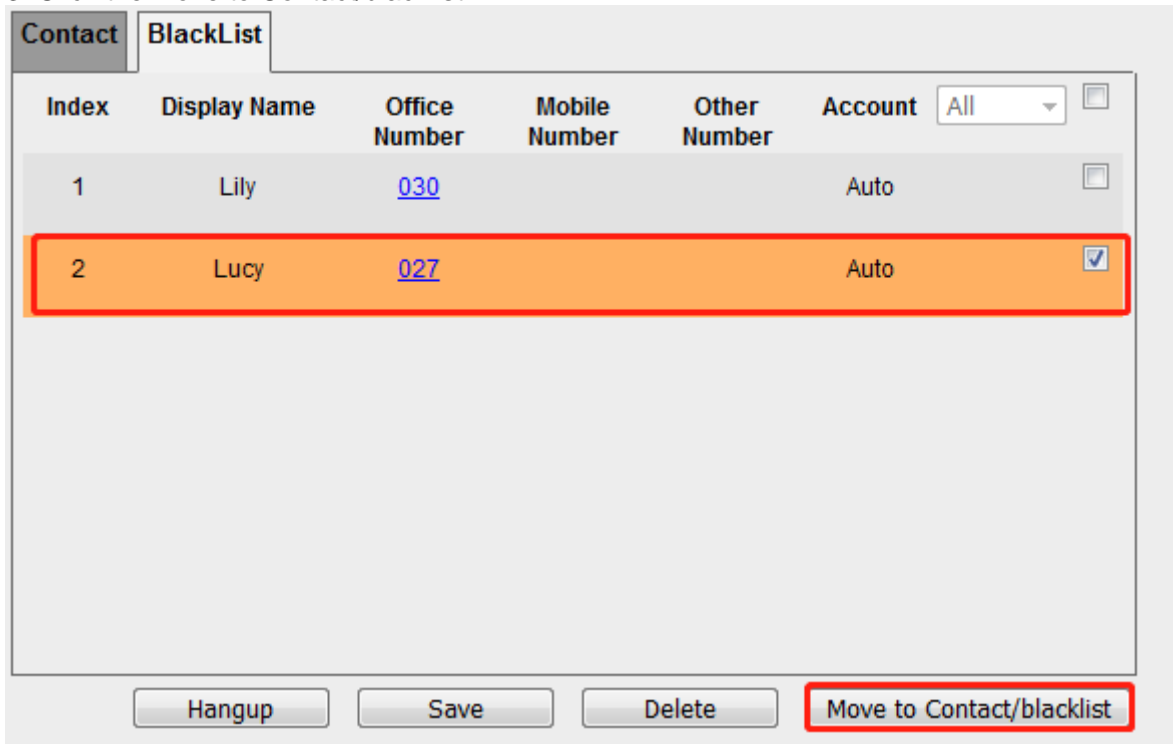

Index	Display Name	Office Number	Mobile Number	Other Number	Account	
1	Lily	030			Auto	<input type="checkbox"/>
2	Lucy	027			Auto	<input checked="" type="checkbox"/>

Buttons: Hangup, Save, Delete, **Move to Contact/blacklist**

Remote Phonebook

To set Remote Phonebook via Web interface:

1. Login the webpage and click Directory→ Remote Phone Book
2. Fill in the URL of the remote file in the Phone Book URL field. For example, <http://10.2.0.140/Phonebook/remotephonebook.xml>
3. Fill in the Name and then click to save the configuration.

Index	PhoneBook URL	Name
1	<input type="text" value="http://10.2.0.140/Phonebook/remotephoneboc"/>	<input type="text" value="test1"/>
2	<input type="text"/>	<input type="text"/>
3	<input type="text"/>	<input type="text"/>
4	<input type="text"/>	<input type="text"/>
5	<input type="text"/>	<input type="text"/>

Update Time Interval(minutes) [?](#)

To check the contacts via Phone interface:

1. Press Directory→ Remote Contacts or Menu→ Directory→ Remote Contacts, and then you can see the item you set.
2. Select the item and press Update.
3. After updating completely, press Enter and you will find the detail.

Note:

Every remote phonebook, only supports 10000 contacts.

To search contact in Remote Contacts:

1. Click the Directory soft key on Idle interface.
2. Select the Remote Contacts and click Enter.
3. Select the desired remote phonebook and click Enter soft key.
4. Click the Search soft key, you can enter the desired part of name or part of number.
5. With the search content to match the contact will be automatically displayed on the LCD within 5 seconds.

LDAP Phonebook

When use the LDAP feature, you can get the LDAP Phonebook directly.

To configure LDAP via Web interface:

1. Login webpage and click Directory→ LDAP
2. Fill in the LDAP Name Filter:
 - a) This parameter specifies the name attributes for LDAP searching. The “%” symbol in the filter stands for the entering string used as the prefix of the filter condition.
 - b) For example, (cn=%), when the name prefix of the cn of the contact record matches the search criteria, the record will be displayed on the IP PHONE LCD.
3. Fill in the LDAP Number Filter: This parameter specifies the number attributes for LDAP searching.
4. Fill in Server Address: Fill in the domain name or IP address of the LDAP Server. For example: 192.168.0.253
5. Port (the port of the LDAP Server), Base, User Name, Password
6. Max.Hits(1-32000): the maximum number of the search results to be returned by the LDAP server.
7. LDAP Display Name: the display name of the contact record displayed on the LCD screen.
8. Filled in the relative value and then click to save the settings.

Following is the example screenshot for the configuration.

LDAP Name Filter	<input type="text" value="(cn=%)"/>	?
LDAP Number Filter	<input type="text" value="((telephoneNumber=%)"/>	?
Server Address	<input type="text" value="192.168.0.107"/>	?
Port	<input type="text" value="389"/>	?
Base	<input type="text" value="dc=pbx,dc=com"/>	?
User Name	<input type="text" value="cn=admin,dc=pbx,dc=cc"/>	?
Password	<input type="password" value="●●●●●●●●"/>	?
Max.Hits(1~32000)	<input type="text" value="32000"/>	?
LDAP Name Attributes	<input type="text"/>	?
LDAP Number Attributes	<input type="text"/>	?
LDAP Display Name	<input type="text" value="cn"/>	?
Protocol	<input checked="" type="radio"/> Version2 <input type="radio"/> Version3	?
LDAP Lookup For Call	<input type="radio"/> On <input checked="" type="radio"/> Off	?
LDAP Sorting Results	<input type="radio"/> On <input checked="" type="radio"/> Off	?
LDAP Synchronize Time(0~9999mins)	<input type="text"/>	?

To configure LDAP Key via Web interface:

1. Click Function Keys→ Line Key→ choose Line Key2(for example)
2. Select LDAP in the Type field.
3. Click to save the configuration.

Line	Type	Mode	Value	Label	Account	Extension
Key1	Line	Default		243	Account 1	
Key2	LDAP	Default			Account 1	

To Configure LDAP Key via Phone interface:

1. Press Menu→ Features→ Function Keys→ Line Keys as Function Keys→ Line Key2
2. Select LDAP in the Type field
3. Press Save or  key to save the configuration.

When press the LDAP Key the LCD will display as following:



To search contact in LDAP contacts:



1. Click the Directory soft key on Idle interface.
2. Select the LDAP Contacts and click Enter.
3. Enter the first character or more of contact's name or number.
4. With the search content to match the contact will be automatically displayed on the LCD within 5 seconds.

Call History Setting

Call History



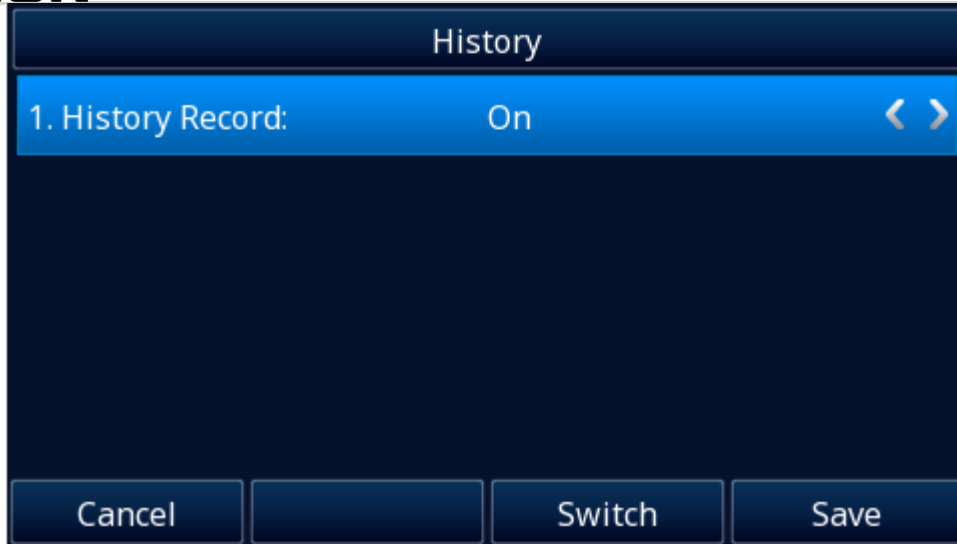

This phone maintains call history lists of Dialed Calls, Received Calls, Missed Calls and Forwarded Calls. The call history list supports up to 100 entries in all on phone interface and more than 1500 items. You can check the call history, dial a call, add a contact or delete an entry from the call history list. You should enable the history record feature in advance.

To enable the history record feature via Phone interface:

1. Press Menu → Features → History
2. Press  and  or Switch soft key set History record: On.
3. Press Save soft key to save the configuration.





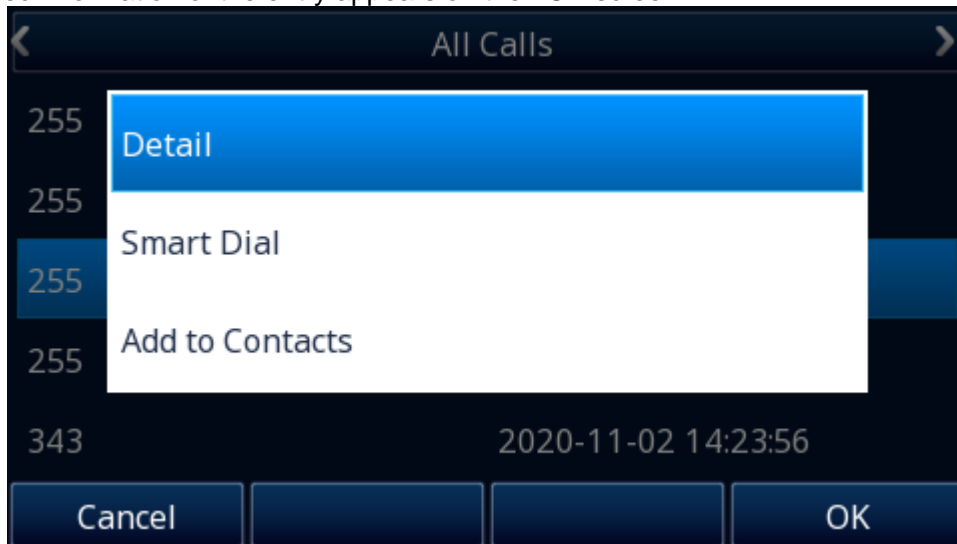

To view the call history via Phone interface:





1. Press the History soft key or press Menu→ History→ All/ Missed/ Received/ Dialed/ Forwarded Calls. The LCD screen displays All Calls list.
2. Press  or  to switch among All Calls, Missed Calls, Received Calls, Dialed Calls and Forwarded Calls.
3. Press  or  to select the desired entry.
4. Press the Option soft key, then select Detail from the prompt list and press the OK soft key.
5. The detailed information of the entry appears on the LCD screen.



To dial a call from Call History via Phone interface:



1. Press the History soft key or press Menu→ History→ All/ Missed/ Received/ Dialed/ Forwarded Calls.
2. Press  or  to switch among All Calls, Missed Calls, Received Calls, Dialed Calls and Forwarded Calls.
3. Press  or  to select the desired entry.
4. Press the send soft key or .

To delete an entry from the call history list via Phone interface:





1. Press the History soft key or press Menu→ History→ All/ Missed/ Received/ Dialed/ Forwarded Calls.
2. Press  or  to switch among All Calls, Missed Calls, Received Calls, Dialed Calls and Forwarded Calls.
3. Press  or  to select the desired entry.
4. Press the Delete soft key.

To delete all entries from the call history list via Phone interface:





1. Press the History soft key or press Menu→ History→ All/ Missed/ Received/ Dialed/ Forwarded Calls.

2. Press  or  to switch among All Calls, Missed Calls, Received Calls, Dialed Calls and Forwarded Calls.
3. Press the Option soft key, and then select Delete All from the prompt list.
4. Press the OK soft key to confirm the deleting or the Cancel soft key to cancel.

To add to Local Contacts from history via Phone interface:

1. Press History soft key or press Menu→ History→ All/ Missed/ Received/ Dialed/ Forwarded Calls
2. Press  and  to select the targeted one. (Press  and  switched among the All Calls, Missed Calls, Received Calls, Dialed Calls and Forwarded Calls).
3. Press Option soft key→ Add to Contacts.
4. Edit the necessary information as Name, Phone number...
5. Press Save soft key or  to add successfully.

To add to blacklist from history via Phone interface:

1. Press History soft key or press Menu→ History→ All/ Missed/ Received/ Dialed/ Forwarded Calls
2. Press  and  to select the targeted one. (Press  and  switched among the All Calls, Missed Calls, Received Calls, Dialed Calls and Forwarded Calls).
3. Press Option soft key→ Add to Blacklist
4. Edit the necessary information as Name, Phone number...
5. Press Save soft key or  to add successfully.

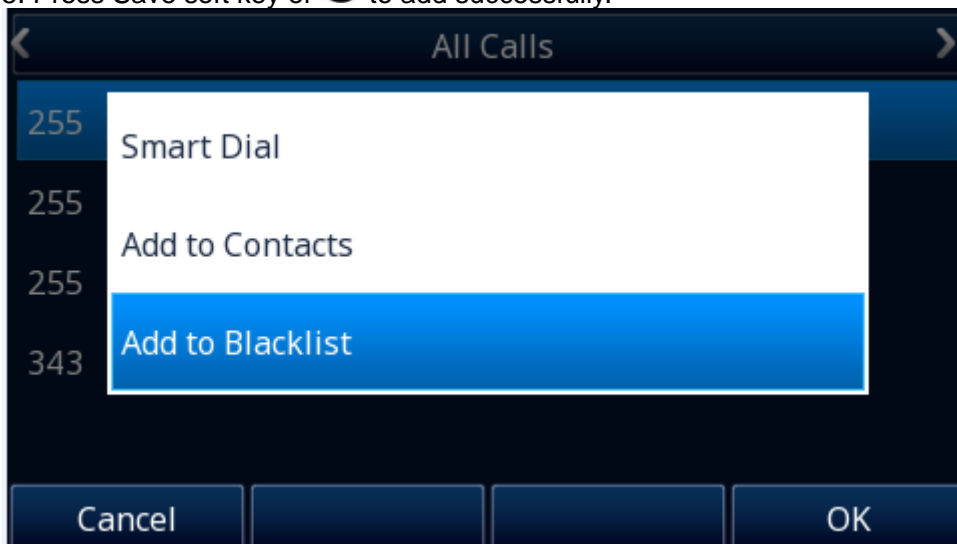

To check the call history via Web interface:

1. Click Directory→ Call History
2. Click Dialed List, Missed List, Received List, or Forwarded List, then you can see the history list.

Dialed List	Missed List	Received List	Forwarded List			
Index	Date	Time	Local Identity	Name	Tel Number	
1	05-07-2019	05:26:21		amy	013	^
2	05-07-2019	04:39:40		004	004	
3	03-04-2019	07:34:57		1105	1105	
4	03-04-2019	07:33:43		1105	1105	
5	03-04-2019	07:32:23		1105	1105	
6	03-04-2019	07:31:09		1105	1105	
7	03-04-2019	07:29:55		1105	1105	
8	03-04-2019	07:28:41		1105	1105	
9	03-04-2019	07:27:27		1105	1105	
10	03-04-2019	07:26:13		1105	1105	
11	03-04-2019	07:24:59		1105	1105	
12	03-04-2019	07:23:45		1105	1105	
13	03-04-2019	07:22:31		1105	1105	
14	03-04-2019	07:21:17		1105	1105	
15	03-04-2019	07:20:02		1105	1105	
16	03-04-2019	07:18:48		1105	1105	
17	03-04-2019	07:17:34		1105	1105	
18	03-04-2019	07:16:09		1105	1105	v

[Export XML](#) [Export Csv](#)

To Dial a call from Call History via Web interface:

1. Click Directory→ Call History
2. Select the desired history item and click Tel Number.
3. Then the call is dialed on phone.

Dialed List	Missed List	Received List	Forwarded List		
Index	Date	Time	Local Identity	Name	tel Number
1	05-07-2019	05:26:21		amy	013
2	05-07-2019	04:39:40		004	004
3	03-04-2019	07:34:57		1105	1105
4	03-04-2019	07:33:43		1105	1105
5	03-04-2019	07:32:23		1105	1105
6	03-04-2019	07:31:09		1105	1105
7	03-04-2019	07:29:55		1105	1105
8	03-04-2019	07:28:41		1105	1105
9	03-04-2019	07:27:27		1105	1105
10	03-04-2019	07:26:13		1105	1105
11	03-04-2019	07:24:59		1105	1105
12	03-04-2019	07:23:45		1105	1105
13	03-04-2019	07:22:31		1105	1105
14	03-04-2019	07:21:17		1105	1105
15	03-04-2019	07:20:02		1105	1105
16	03-04-2019	07:18:48		1105	1105
17	03-04-2019	07:17:34		1105	1105
18	03-04-2019	07:16:09		1105	1105



Export XML Export Csv

Audio Settings

Ring Tone

You can adjust the type and volume of the ring tone.

To adjust the Ring Tone Type via Phone interface:

1. Press Menu → Settings → Basic Setting → Ring Tone.
2. Press  and  to select the aimed one.
3. Press  or Save soft key to save the configuration.



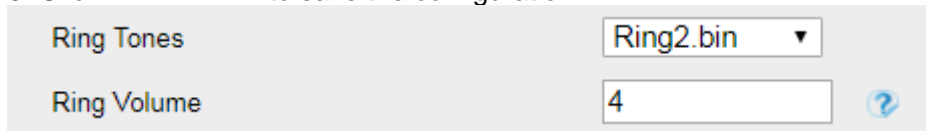

To adjust the Ring Tone Type via Web interface

1. Setting→ Preference→ Ring Tones
2. Select the wanted one and enter the Ring Volume
3. Click to save the configuration.



To configure Distinctive Ring Tone via Phone interface

1. Press Directory → Local Contacts → Contacts
2. Select the target contact.
3. Press Option soft key and select detail to edit the contact.
4. Press  and  to select the wanted Ring Tone for the contact
5. Press Save soft key to save the contact.

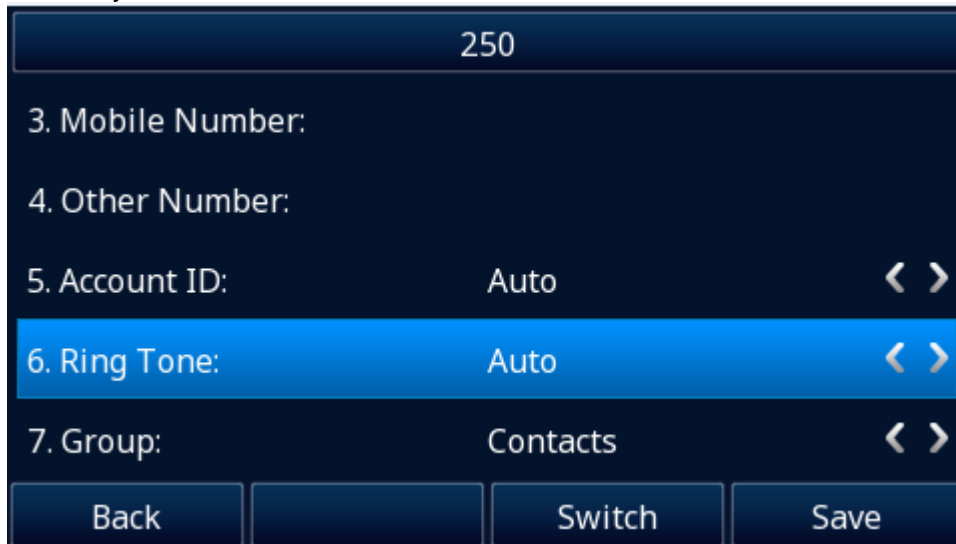

To configure Distinctive Ring Tone via Web interface

1. Directory→ Directory→ Contact
2. Select the target contact.
3. Choose the Ring Tone you want to use.
4. Click → to save the configuration.

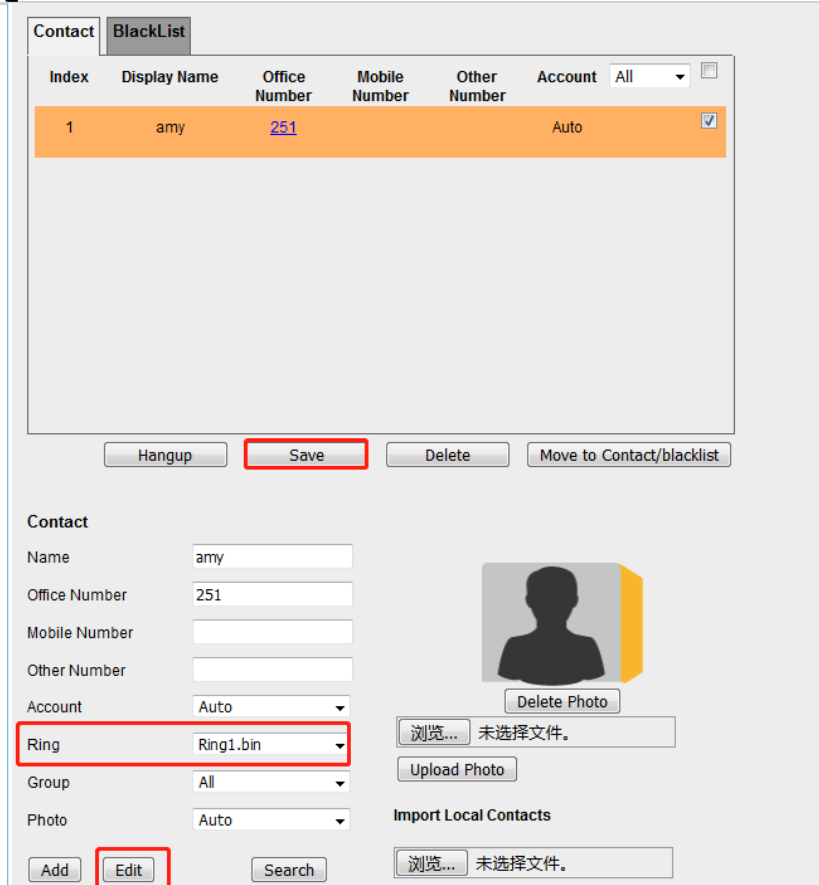

Volume

You can adjust the volume for the phone by the volume keys: and .

To adjust the Ring tone volume via Phone interface:

- Option 1: To press and on the idle page
- Option 2: To press and during the call is ringing.

To adjust the handset volume via Phone interface:

Press and during a call in handset mode.

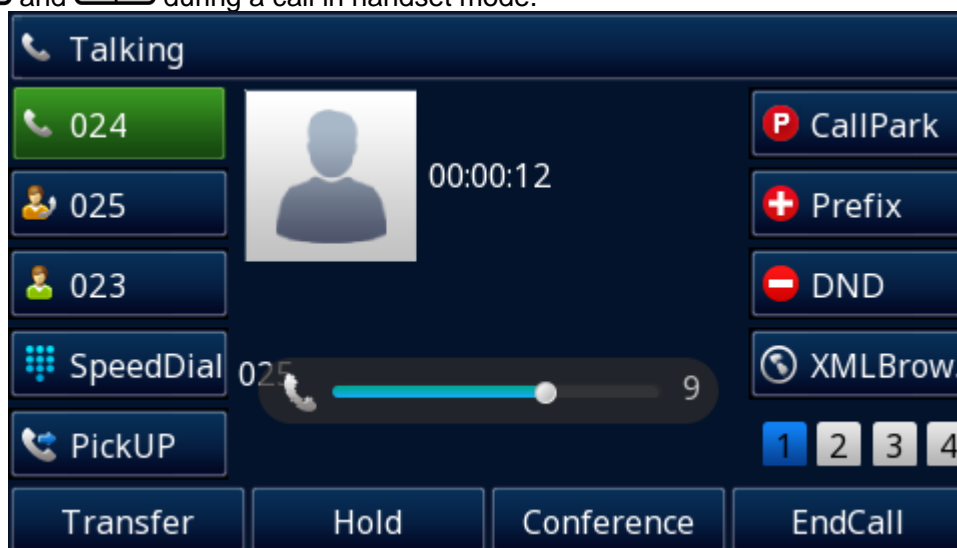

To adjust the headset volume via Phone interface:

Press and during a call in headset mode.

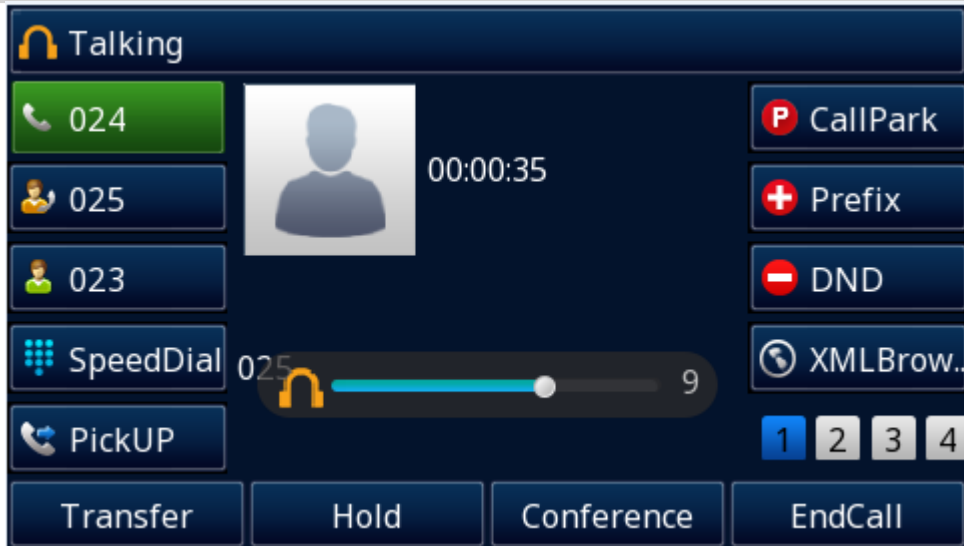

To adjust the speaker Volume via Phone interface:

Press and during a call in speaker mode.

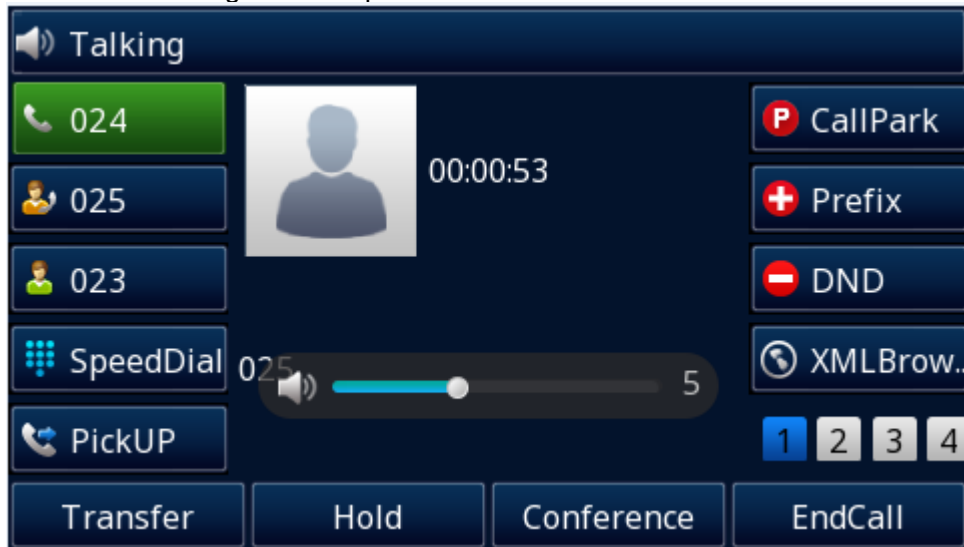

Voice Mail Tone

This option can set whether to play the beep for phone's voice mail.

1. Login webpage, and click the Setting→ Preference
2. Select On or Off for Voice Mail Tone.
3. Click for the setting.

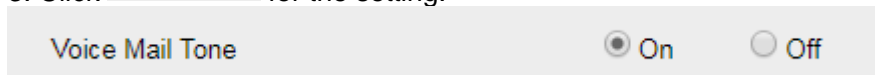

Play Hold Tone

When you hold the phone, whether to play hold tone.

1. Login webpage, and click the Setting→ Preference
2. Set On or Off for Play Hold Tone.
3. Click for the setting.

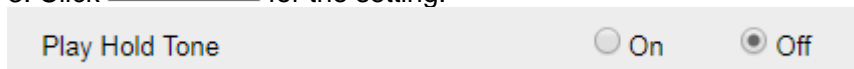

When you hold the phone, how many seconds to play beep?

1. Login webpage, and click the Setting→ Preference
2. Set the value for Play Hold Tone Delay.
3. Click for the setting.

Play Hold Tone Delay	<input type="text" value="3"/>
----------------------	--------------------------------

Voice

Handfree AGC

AGC is the automatic gain control, which amplifies the sound according to the loudness of the speech during use. The most ideal effect when using AGC is that when the sound source is off, when the mic is closer or farther, the sound level on the opposite end is the same.

To configure Handfree AGC via Web interface:

1. Click Setting → Voice.
2. Enable the Handfree AGC field (Default).
3. Click to save the configuration.

Preference	Hand-free AGC	<input type="radio"/> Disable <input checked="" type="radio"/> Enable
Features	Volume Amplification	
BLF Settings	HandSet Send Volume	<input type="text" value="0dB default"/>
Line Settings	HeadSet Send Volume	<input type="text" value="0dB default"/>
Date&Time	HandFree Send Volume	<input type="text" value="0dB default"/>
Tones	Handset extra loud	<input type="text" value="0dB default"/>
Voice	Headset extra loud	<input type="text" value="0dB default"/>
SMS	Handfree extra loud	<input type="text" value="0dB default"/>
Action URL	Mute Type	<input type="text" value="Comfort Noise"/>
Softkey layout	VAD Eanble	<input checked="" type="radio"/> Disable <input type="radio"/> Enable
TR069	EDRC Enable	<input type="radio"/> Disable <input checked="" type="radio"/> Low <input type="radio"/> Medium <input type="radio"/> High
SIP	Jitter Buffer Type	<input type="radio"/> Fixed <input checked="" type="radio"/> Adaptive
Power Saving	Jitter Buffer Length	<input checked="" type="radio"/> Low <input type="radio"/> Medium <input type="radio"/> High
	<input type="button" value="SaveSet"/>	<input type="button" value="Cancel"/>

Handset Send Volume

A fixed gain that controls the volume sent by the Handset.

The AGC feature for handset is enabled by default. If you set this option, the AGC feature for handset will be closed.

To configure Handset Send Volume via Web interface:

1. Click Setting → Voice.
2. Select the desired value in the Handset Send Volume field.
3. Click to save the configuration.

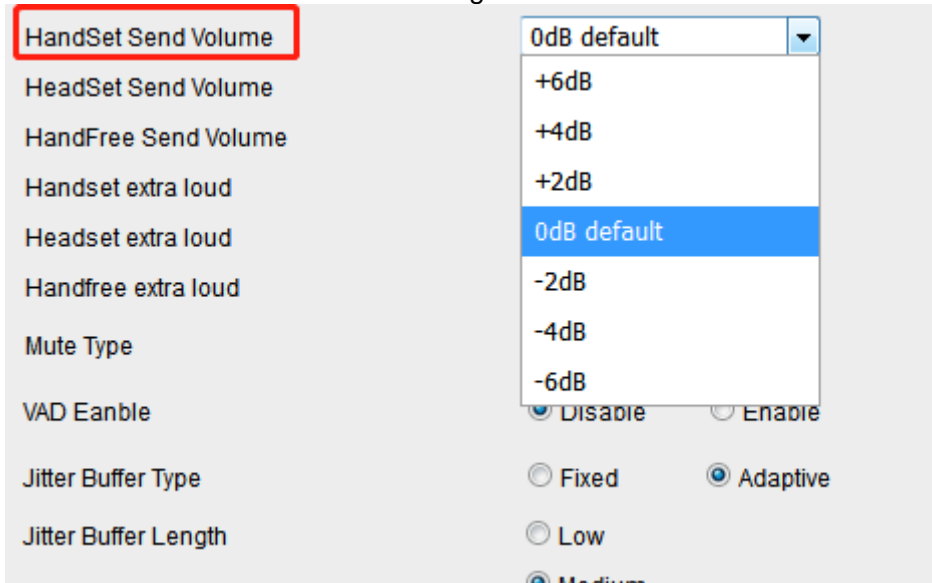

HandSet Send Volume

HeadSet Send Volume

HandFree Send Volume

Handset extra loud

Headset extra loud

Handfree extra loud

Mute Type

VAD Eanble

Jitter Buffer Type

Jitter Buffer Length

0dB default

+6dB

+4dB

+2dB

0dB default

-2dB

-4dB

-6dB

Disable Enable

Fixed Adaptive

Low Medium

Headset Send Volume

A fixed gain that controls the volume sent by the Headset.

To configure Headset Send Volume via Web interface:

1. Click Setting → Voice.
2. Select the desired value in the Headset Send Volume field.
3. Click to save the configuration.

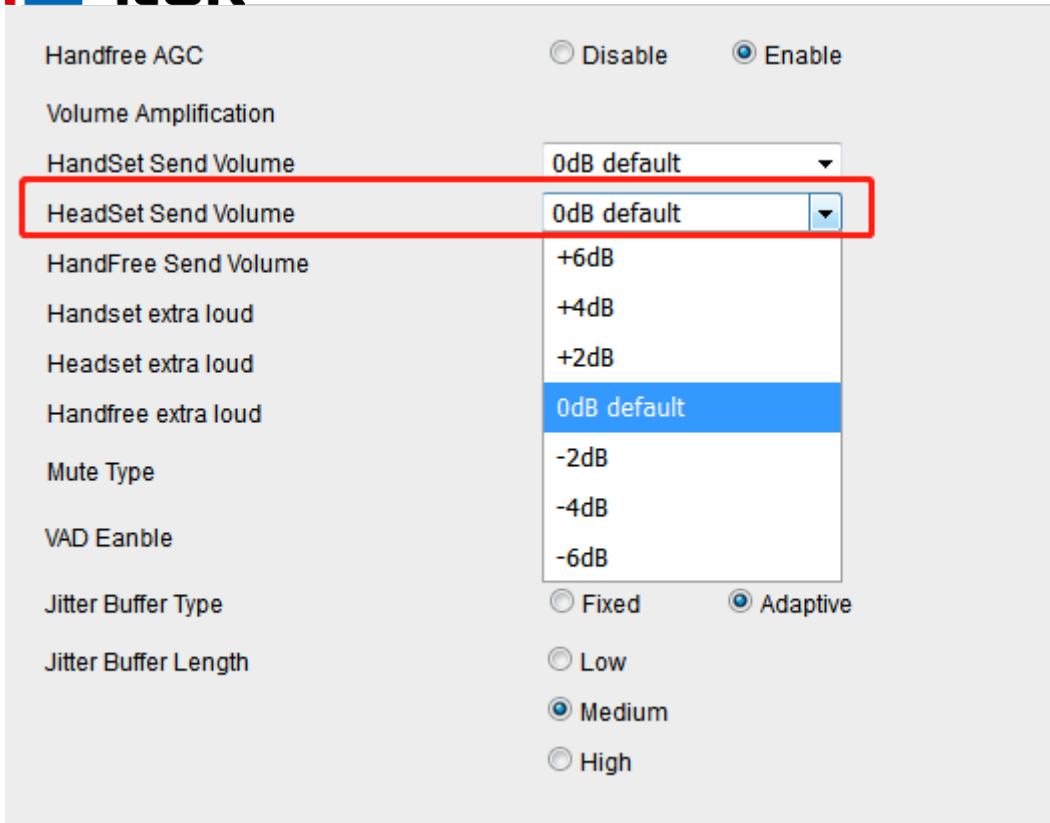

Handfree AGC Disable Enable

Volume Amplification

HandSet Send Volume 0dB default

HeadSet Send Volume 0dB default

HandFree Send Volume +6dB

Handset extra loud +4dB

Headset extra loud +2dB

Handfree extra loud 0dB default

Mute Type -2dB

VAD Enable -4dB

Jitter Buffer Type Fixed Adaptive

Jitter Buffer Length Low Medium High

Handfree Send Volume

A fixed gain that controls the volume sent by the Handfree (speakerphone).
If Handfree AGC is enable, Handfree Send Volume option will not work.

To configure Handfree Send Volume via Web interface:

1. Click Setting → Voice.
2. Select the desired value in the Handfree Send Volume field.
3. Click to save the configuration.

Extra Loud

To configure Handset /Headset/Handfree extra loud via Web interface:

Handset /Headset/Handfree extra loud can control the size of the sound emitted from the speaker, and you can control an additional +2~+12 db.

1. Click Setting → Voice.
2. Select the desired value in the Handset /Headset/Handfree extra loud field.
3. Click to save the configuration.

Handfree AGC	<input type="radio"/> Disable <input checked="" type="radio"/> Enable
Volume Amplification	
HandSet Send Volume	0dB default
HeadSet Send Volume	0dB default
HandFree Send Volume	0dB default
Handset extra loud	0dB default
Headset extra loud	0dB default
Handfree extra loud	+2dB
Mute Type	+4dB
VAD Eanble	+6dB
Jitter Buffer Type	+8dB
Jitter Buffer Length	+10dB
	+12dB
	<input checked="" type="radio"/> Medium
	<input type="radio"/> High

Note:
Only when the volume adjustment on the LCD is greater than +7, the extra loud will take effect.

USB

USB Recording

You can record active calls onto a USB flash drive connected to your phones, and the recordings will be saved as *.wav files.

USB recording is not available by default. Please contact your system administrator for enabling the feature.

Supported model: UC926U(S) UC924U(W) UC923U UC921U

Note:

The size of a single recording file should be less than 2G.

Before you use USB Recording:

Connect your USB flash driver to your phone, and the phone will show that U Disk Connected.

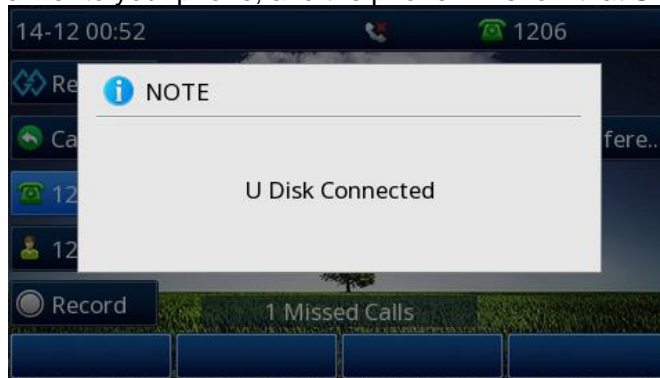

To record a call:

- During a call, press More soft key → Start Rec soft key

When recording starts, the recording icon and recording duration are displayed in the notification bar, and the recording start and available rec time are displayed in a note:

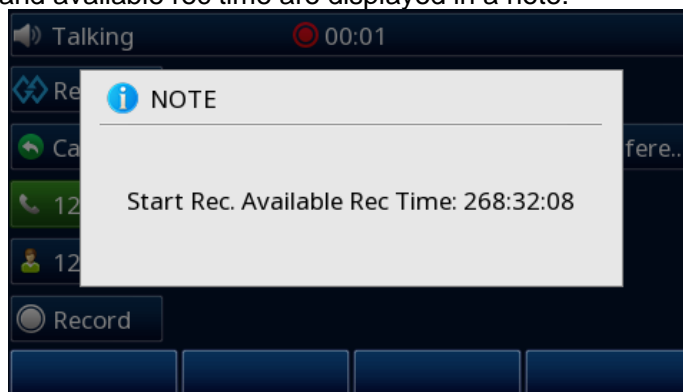

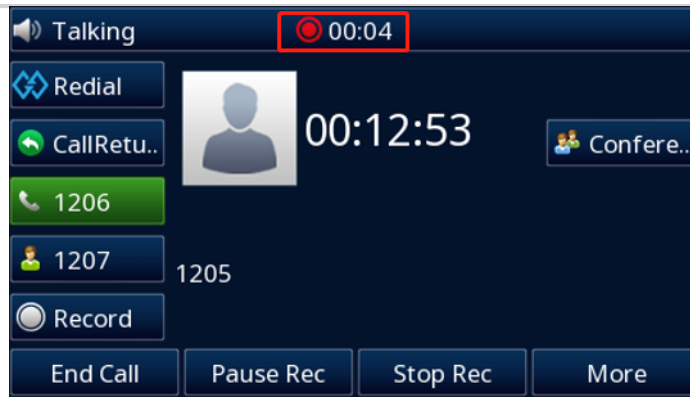

To pause/resume a recording:

- Press Pause Rec soft key to pause the current recording. When a recording is paused, the recording pause icon are displayed in the notification bar.

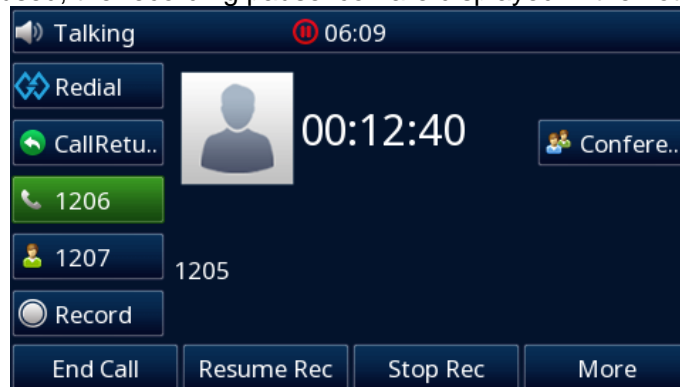

- Press Resume Rec soft key to resume the paused recording.

To stop a recording:

There are two ways to stop recording:

1. End the call directly
2. Press Stop Rec soft key

The call recording will be automatically saved in. Wav format in the corresponding folder of USB drive

Manage your recordings

After stopping recording, you can manage the recordings on your phone. Make sure the USB flash drive is still inserted in the phone.

To listen a recording:

You can view all recorded files in the Browse recordings.

1. Press soft key Menu→ USB→Browse recordings



2. press and to choose the recording you want to play
3. Press or play soft key to listen the recording

To control playback Progress:

When playing a recording, you can pause, fast forward and rewind.



Pause: Press  to pause or resume the recording.

Fast forward and rewind: Press  and  soft key to fast forward or rewind the recording

To toggle list loop mode:

- Press  to adjust the list loop mode.

There are four loop modes to choose from:



 mode will loop through all the music in the list.

 mode will loop single current recording.

 mode will play the recording until the end of the list.

 mode will only play to end the current recording.

To delete recordings:

1. Press soft key Menu → USB → Browse recordings
2. Press  and  to choose the recording you want to delete
3. Press Delete soft key

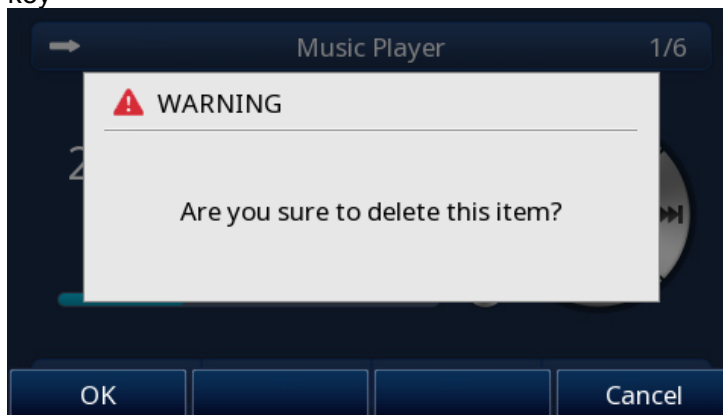

4. Press OK soft key

You can also delete the recording that is playing:

1. Press  soft key
2. Press OK soft key

USB Headset

You can use a USB headset to handle calls on the phones.

After connecting a headset to your phone, you can activate the headset mode and use the headset when answering and placing calls. If you do not want to use a headset to handle calls, you can deactivate the headset mode.

Supported model: UC926U(S) UC924U(W) UC923U UC921U

To use a USB Headset:

1. Plug the headset into the USB port

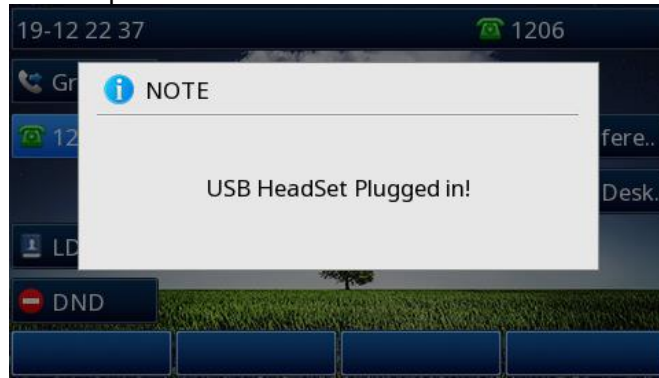

2. Press the headset key to open Headset mode
 3. Press the headset key again to close Headset mode
- For information on how to configure the headset mode. see [Headset Mode](#)

Adding a Wallpaper from a USB Flash Drive

You can use a picture that is stored on a USB flash drive as the wallpaper of your phone. Make sure that the picture is in Browse photos directory of your USB flash drive, and the USB flash drive is connected to your phone successfully. When you connect the USB flash drive successfully, the phone will pop up a note that U Disk Connected.

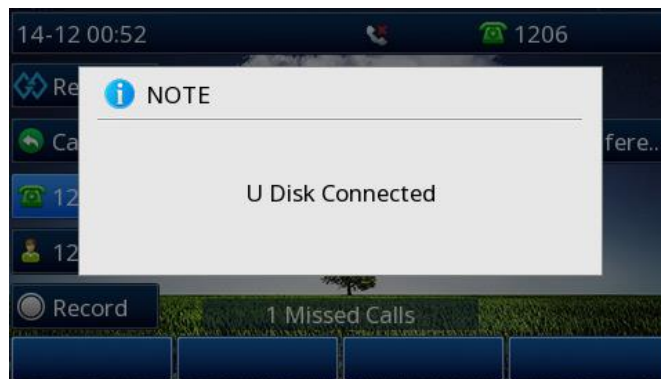

Supported model: UC926U(S) UC926(E) UC924U(W) UC924(E) UC923U UC921U

To add a wallpaper from a USB Flash Drive:

1. Press Menu soft key
2. Enter the USB app and select Browse photos
3. Press and to choose the picture and you can press to view the pictures
4. Press Set As soft key
5. Press and to choose Wallpaper

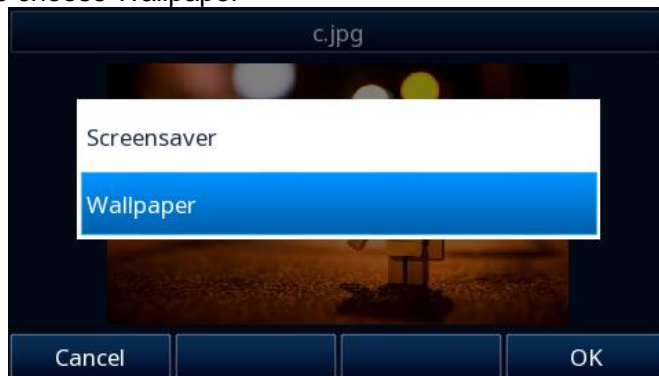

6. Press OK soft key
- The phone wallpaper will change to the selected picture

Note:

Photo size should be less than 100KB, name length should be less than 48.
You can only upload screen photos in format of '.bmp' and '.jpg'.

Adding a Screen Saver from a USB Flash Driver

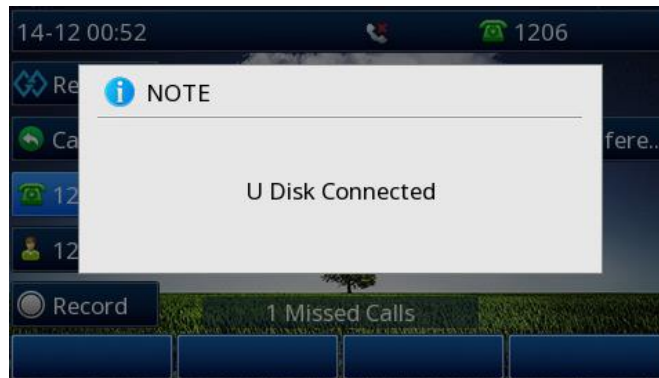

You can use a picture that is stored on a USB flash drive as the screen saver of your phone. Make sure the USB flash drive is connected to your phone successfully.

When you connect the USB flash drive successfully, the phone will pop up a note that U Disk Connected.





Supported model: UC926U(S) UC926(E) UC924U(W) UC923U UC921U

To add a screen saver from a USB Flash Drive:

1. Press Menu soft key
2. Enter the USB app and select Browse photos
3. Press  and  to choose the picture and you can press  to view the pictures
4. Press Set As soft key



5. Press  and  to choose Screen Saver
6. Press OK soft key

The phone screen saver will change to the selected picture

Note:

Photo size should be less than 100KB, name length should be less than 48.
You can only upload screen photos in format of '.bmp' and '.jpg'.

Bluetooth

UC926U connects to a wide range of Bluetooth Headset, compatible with Bluetooth specification V4.0 and backwards compatible with 1.1, 1.2, 2.0 and 3.0.

Supported model: built-in: UC926U(E) UC924W(E) UC921E UC912E
with dongle WFBT60: UC926S UC924U UC923U UC921U

How to Activate Bluetooth?

To activate Bluetooth via Phone interface:

1. Find Menu then navigate as follows:

Menu->Settings->Basic Setting->Bluetooth:

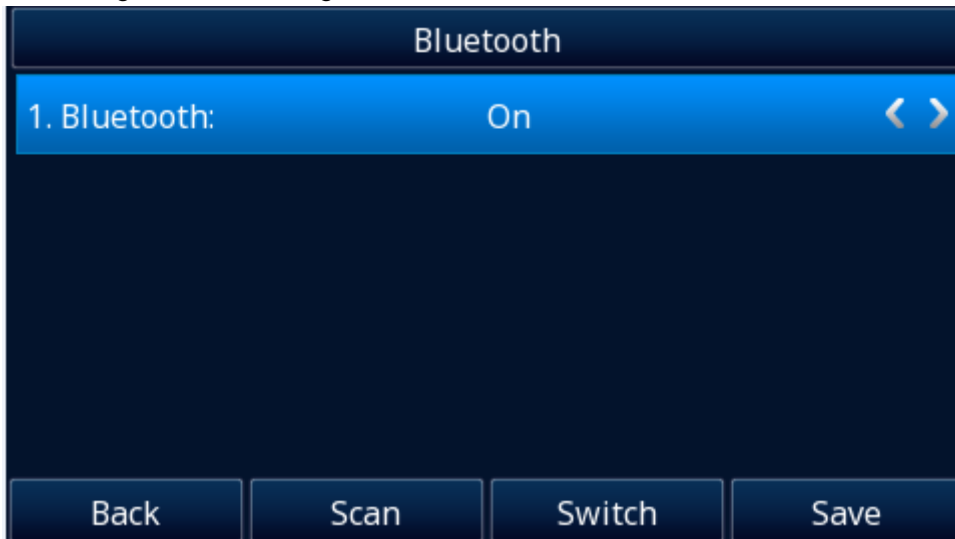

2. Press the save soft key to save the configuration.
3. You will see the Bluetooth icon on phone's homepage status bar during the idle status.
(This icon means that phone has no pair the Bluetooth device)



How to Pair the Bluetooth Headset to the Phone?

Open the Bluetooth pairing mode on Bluetooth headset:

1. Turn on the Bluetooth headset.
2. Long press the multifunction key on the Bluetooth headset until the indicator LED alternately flashes red and blue.

The Bluetooth headset is in pairing mode.

How to scan the Bluetooth headset device on phone interface:

1. Select "Paired Bluetooth Device". Press the "Scan" button on phone interface:

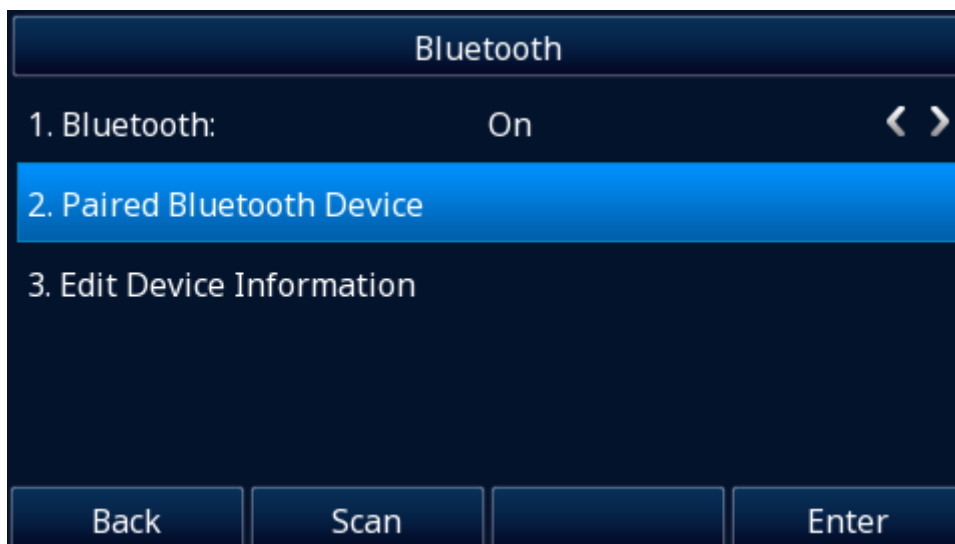

2. The phone will enter the scan interface, the phone starts searching for Bluetooth headsets within the working range of 10 meters (32 feet).

3. All detected Bluetooth headsets will display on the phone:

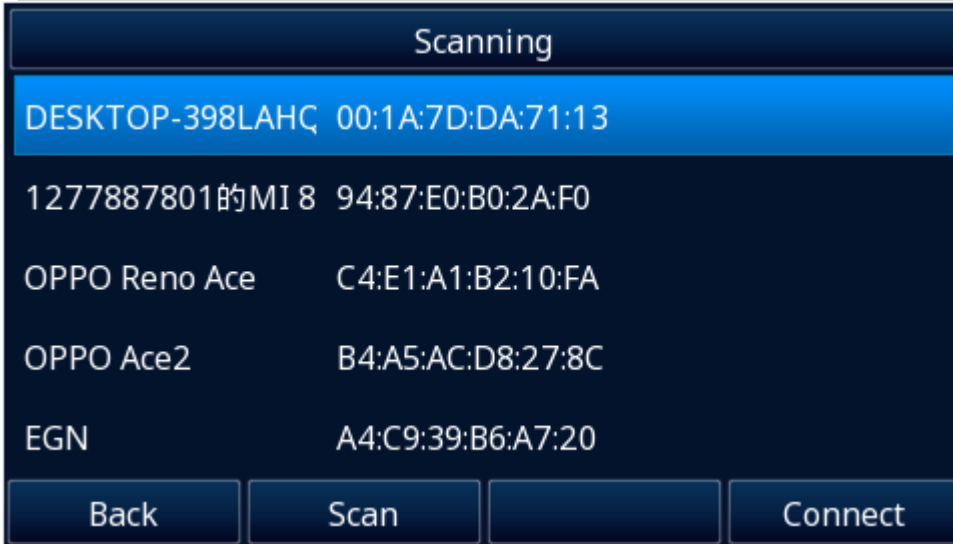

4. Choose the desired Bluetooth Device from the list and connect to it:

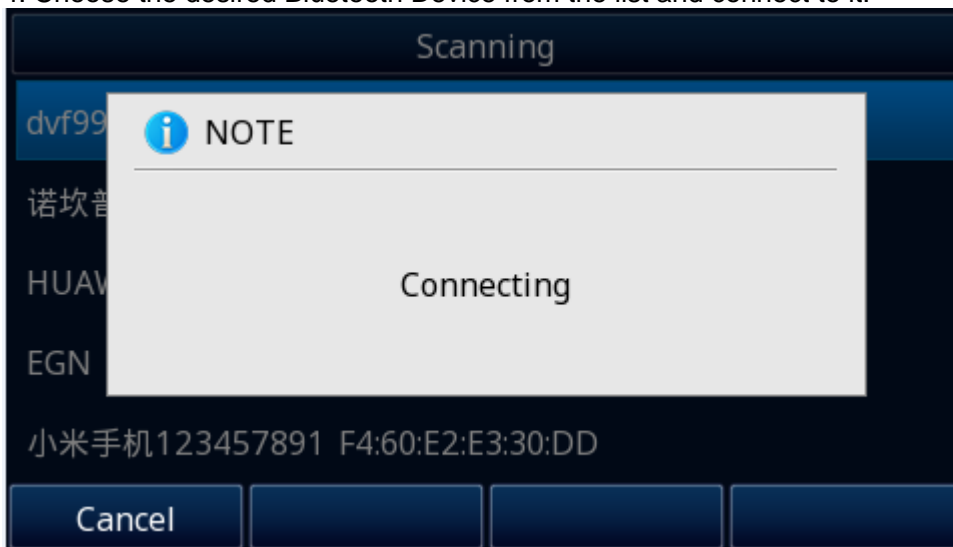

5. If the Bluetooth Device is connected/paired successfully, you will see the “Connect Success!” and connected successfully icon.

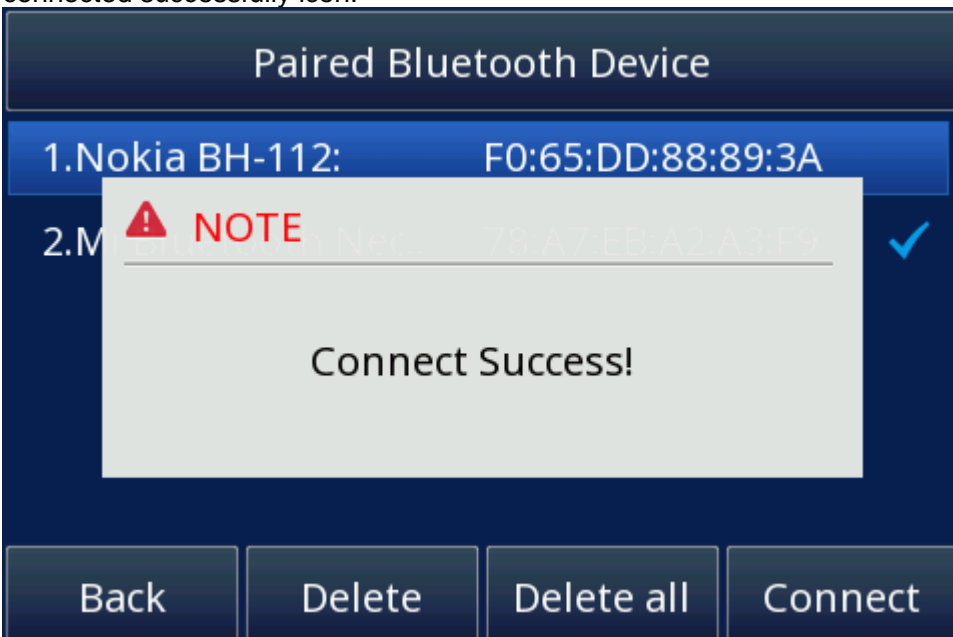



6. If you want to disconnect with this Bluetooth device, you can press the “Enter” button, then press the “Disconnect” button.

7. When you back to idle interface, you will see the connected successfully icon:



How to edit device information?

How to edit device information on phone interface:

1. Find Menu then navigate as follows:
Menu->Settings->Basic Setting->Bluetooth: Edit Device Information.

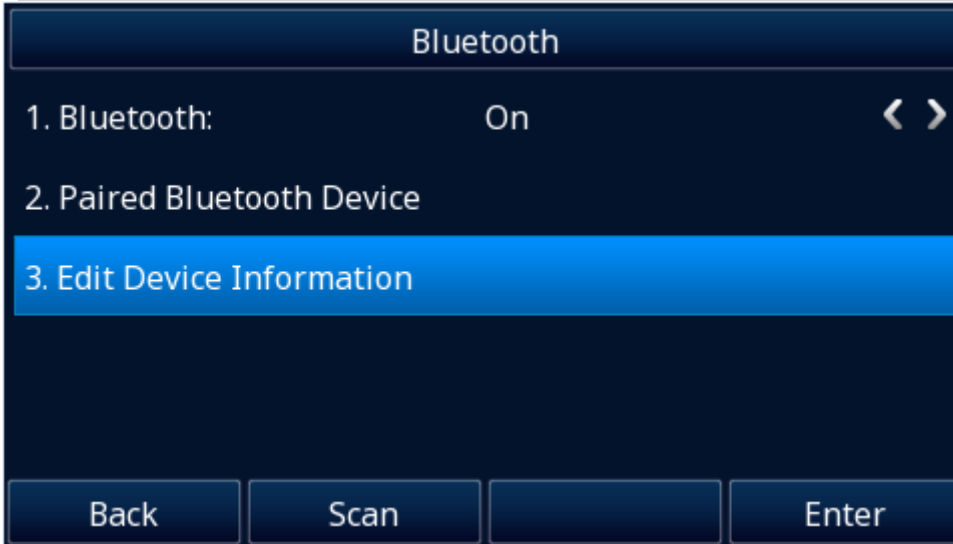

2. Press the enter button, you can edit the Device Name:

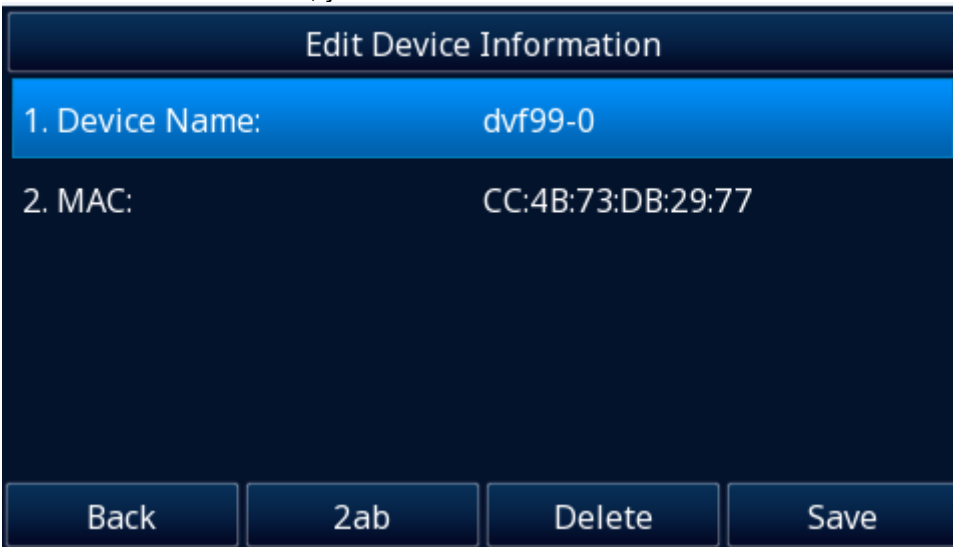

Note:

The phone must be in the headphone mode to normally use the Bluetooth function.

How to answer an incoming call?

With the Bluetooth headset paired, press the multifunction key on the Bluetooth headset to answer an incoming call.

How to adjust the earphone volume during a call?

With the Bluetooth headset paired, you can do the following:

- Press the Volume key (+) on the Bluetooth headset to increase the volume. Press the Volume key (-) on the Bluetooth headset to decrease the volume.
- Press the Volume key (+) on the phone to increase the volume. Press the Volume key (-) on the phone to decrease the volume.

To end a call:

With the Bluetooth headset paired, press the multifunction key on the Bluetooth headset to end a call.

Wi-Fi

When the Wi-Fi feature is enabled, the IP phone will automatically scan the available wireless networks. All the available wireless networks will display in scanning list on the LCD screen. The Wi-Fi feature can be configured in two different ways: Manual and Provision.

Supported model:

Built-in dual band(2.4GHz/5GHz) Wi-Fi: UC926U UC924W UC921E UC912E

Built-in 2.4GHz Wi-Fi: UC926E UC924E UC921E UC912E UC902E

Dual band(2.4GHz/5GHz) Wi-Fi with Dongle WFBT60: UC926S UC924U UC923U UC921U

How to Enable Wi-Fi feature?

Enabling Wi-Fi feature via Phone interface:

1. Find Menu then navigate as follows Menu->Settings->Basic Setting->Wi-Fi. Press the Switch button.

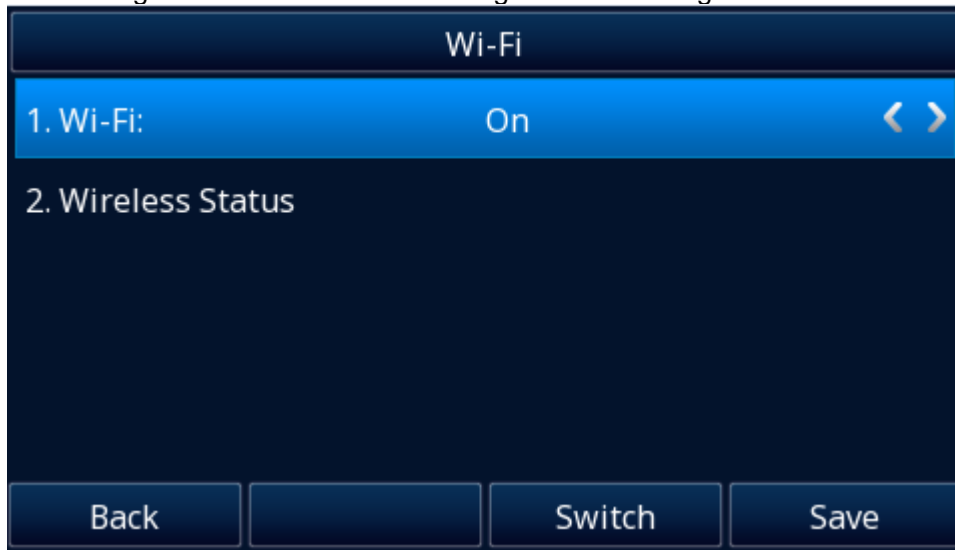

2. Press the Save soft key.



How to Connect the UC926U to an Available Wireless Network?

Connect to an available wireless network via Phone interface:

1. Find Menu then navigate as follows:

Menu->Settings->Basic Setting->Wi-Fi: Available Network(s)

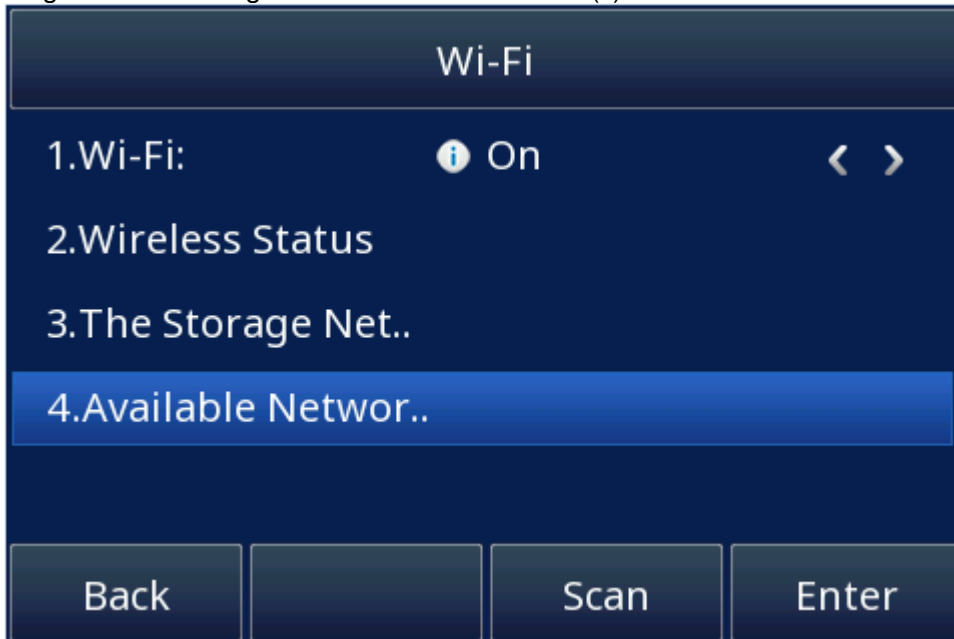

2. Press the Enter button, you will see many available wireless networks:



1. You can press the “scan” button to scan the wireless network.
2. You can press the “Detail” button to view a wireless network’s detail information.
3. Choose desired wireless network and then press the “Connect” button:

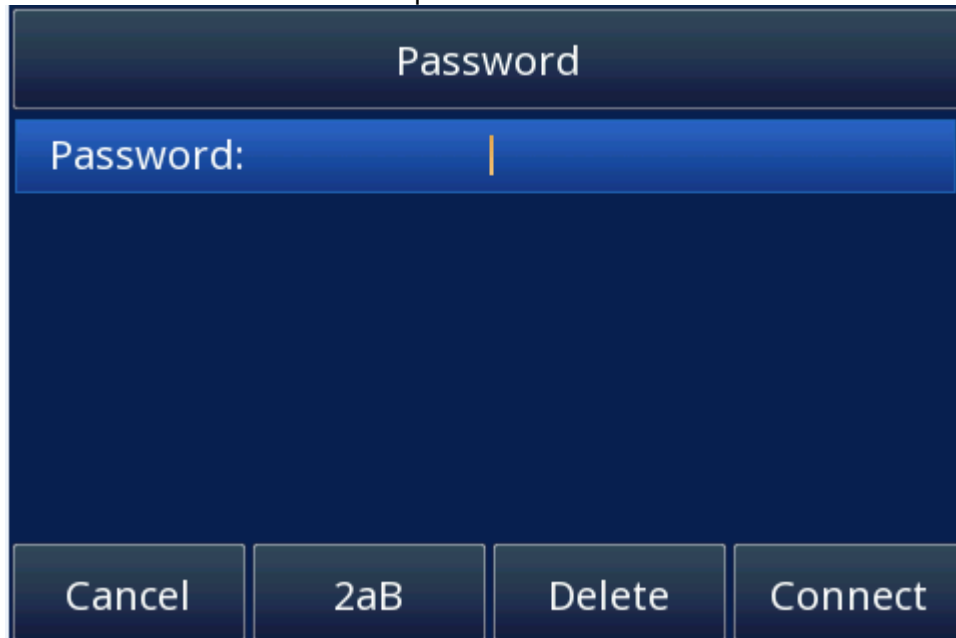

4. You must enter the wireless network’s password:

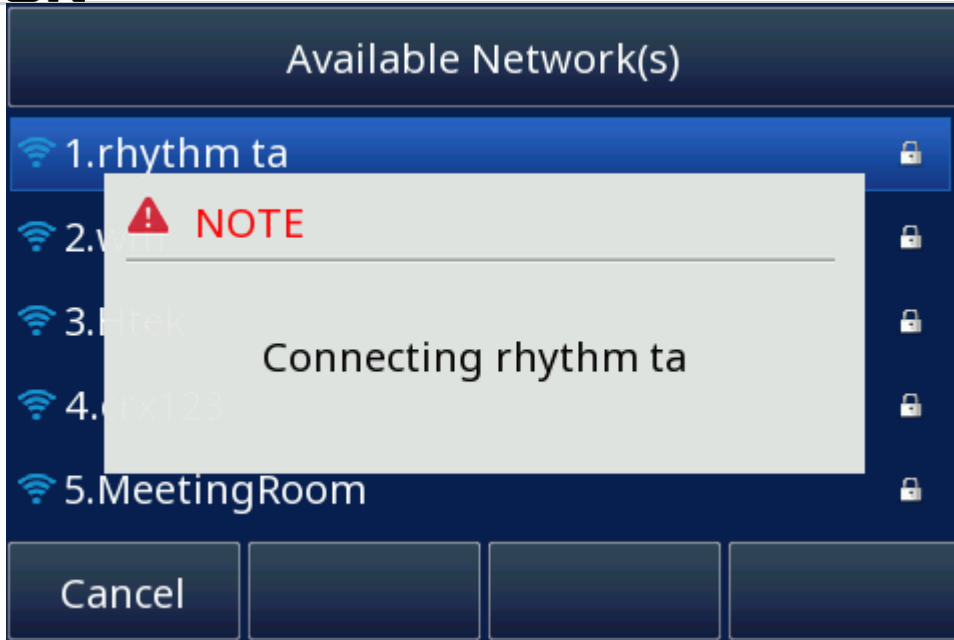

5. If the wireless network's password is correct, the wireless network will connect successfully:



How to view Wireless Network status?

1. You will see the wireless network successfully connected icon when phone connects wireless network successfully and back to idle interface:



2. You can see the wireless network's detail information as follow: Menu->Status->Information:



Or as follow:
Menu->Settings->Basic Setting->Wi-Fi: wireless status:

How to Disconnect Wireless Network?

Disconnect wireless network via Phone interface:

1. Enter Menu->Settings->Basic Setting->Wi-Fi: The Storage Network
2. Select the current connected Wi-Fi.
3. Press Disconnect Soft key.

How to Manually Add a Wireless Network?

Add a Wireless Network Manually via Phone interface:

1. Enter Menu->Settings->Basic Setting->Wi-Fi: The Storage Network.
2. Press the "Add" button and then complete the fields:

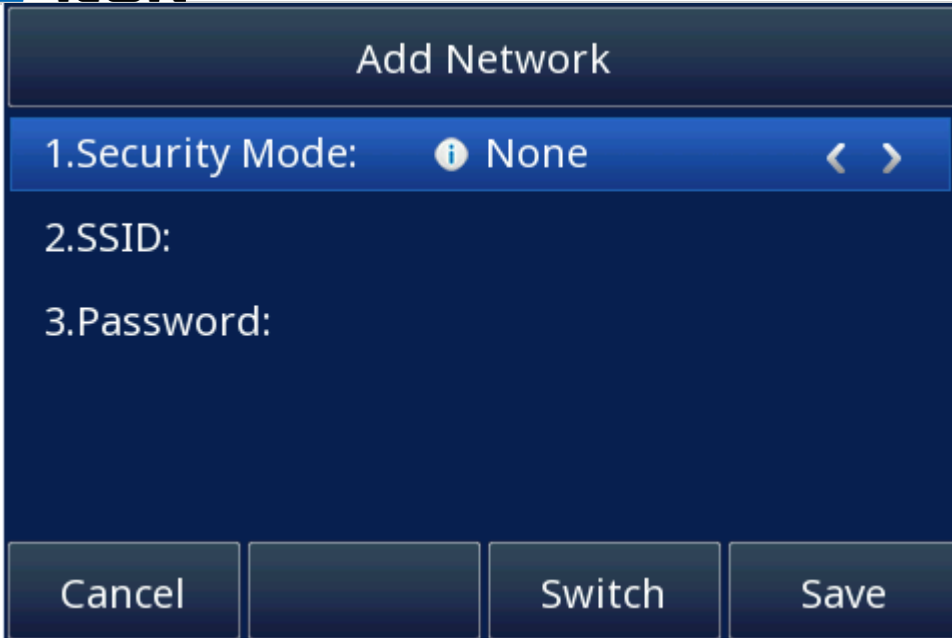

Select a Security Mode

Enter the desired wireless network (SSID)

If the wireless network is secure, please enter its password in the password field.

3. Press the “Save” button, and then you can choose this wireless network to connect it.

How to Disable Wi-Fi feature?

To disable the Wi-Fi feature via Phone interface:

1. Find Menu then navigate as follows Menu->Settings->Basic Setting->Wi-Fi:
2. Press the Switch button to turn off Wi-Fi feature.
3. Press the Save button to save the configuration.

Function Key

The function key supports the **Line Label Length**, **Line Page Indicator**, **BLF list MODE**, **line key as cancel**, **BLF blink**.

Line Label Length: If this option is set Long label, then the label’s length will be longer, it is used if the string is too long.

Line Page Indicator: Enable this option when the IP Phone has been configured for multiple pages. For example, when current page is the first page, the second page has a BLF and BLF’s status is changed, the second page’s button will flash the red indicator.
UC926U has 36 Function Keys.

BLF list MODE: You can configure the line key as BLF List manually, automatically, or automatically to the expansion.

Line key as cancel: Used on BLF Key type. If there is a BLF key monitoring extension A and you are talking with the extension, you can press the BLF key to end the call if this option is Enable.

BLF blink: Turn this option on to make the BLF key blink when the monitored extension is ringing or talking.

Line

Key type Line supports two modes: Default and Lock.

Default mode: Line Key will only be displayed on the configured page.

Lock mode: The line key will reflect on the same position on every page when the line key is set as the Line type.

If set to Lock mode, the DSSKey at the corresponding location on the others page will be locked.

Line	Type	Mode	Value	Label	Account	Extension
Key1	Line	Lock		025	Account 1	
Key2	BLF	Default	136		Account 1	
Key3	BLF	Default	137		Account 1	
Key4	Speed Dial	Default	136		Account 1	
Key5	Voice Mail	Default	999		Account 1	
Key6	Direct Pickup	Default	*20*		Account 1	
Key7	Prefix	Default	1		Account 1	
Key8	LDAP	Default			Account 1	
Key9	ACD	Default			Account 1	
Key10	URL	Default	443		Account 1	
Key11	N/A	Default			Account 1	
Key12	N/A	Default			Account 1	
Key13	N/A	Default			Account 1	
Key14	N/A	Default			Account 1	
Key15	N/A	Default			Account 1	

To configure Line feature via phone interface

1. Press Menu → Features → Function → Line → Line Key1 (for example)

2. Press  and  key to select the Line in the Type field.

3. Select the Account ID.

4. Press  or Save soft key to save the configuration.

Then the selected Line Key will work as Line.

To configure Line Feature via Web interface

1. Click Function Keys → Line Key.

2. Select the wanted Line Key and set as Line.

3. Select the Account.

4. Click the  button to save the configuration.



Line	Type	Mode	Value	Label	Account	Extension
Key1	Line	Default		025	Account 1	
Key2	BLF	Default	136		Account 1	
Key3	BLF	Default	137		Account 1	

Speed Dial

With this feature, you can dial one number by pressing the configured Speed Dial key.

To configure Speed Dial feature via Phone interface

1. Press Menu→ Features→ Function Keys→ Line keys as Function Keys→ Line Key2(for example)

2. Press  and  key to select the Speed Dial in the Type field.

3. Enter the targeted Number in the Value field.

4. Select the Account ID.

5. Press  or Save soft key to save the configuration.

Then the selected Line Key will work as Speed Dial.

To configure Speed Dial feature via Web interface

1. Click Function Keys→ Line Key.

2. Select the wanted Line Key and set as Speed Dial.

3. Enter the desired phone number in the Value field.

4. Select the Account

5. Click the  button to save the configuration.

Line	Type	Mode	Value	Label	Account	Extension
Key1	Line	Default		243	Account 1	
Key2	Speed Dial	Default	245		Account 1	

BLF

You can use the BLF (Busy Lamp Field) feature to monitor a specific extension number whether the extension is busy or free.

1. When the extension you are monitoring is idle, the light is steady green.

2. When the monitored extension is ringing, the light is blinking red, press the BLF key to pick the IP Phone up directly.



3. When the monitored extension is calling or in a conversation, the light is steady red.

To configure a BLF key via phone interface

1. Press Menu→ Features→ Function→ Line Keys as Function Key → Line Key1(for example).

2. Press  and  key to select the BLF in the Type field.

3. Enter the targeted Number in the Value field.

4. Press  and  key to select the Account ID.

5. Enter the Pickup Code.

6. Press  or Save soft key to save the configuration.

To configure a BLF key via Web interface

1. Click Function Keys→ Line Key.
2. Select the desired Line Key and select BLF in the Type field.
3. Enter the monitored phone number in the Value field.
4. Select the Account.
5. Fill in the Extension.
6. Click to save the configuration.

Line	Type	Mode	Value	Label	Account	Extension
Key1	Line	Default		025	Account 1	
Key2	BLF	Default	136		Account 1	

DTMF

When the key is configured as DTMF key, you can send out the desired DTMF number during the conversation.



To use this feature, you should sure that the DTMF Tone is on.

To configure the DTMF Tone via Web interface

1. Click Setting→ Preference
2. Select On for Keypad DTMF Tone.
3. Click to save the configuration.

Keypad DTMF Tone On Off

To configure the DTMF via Phone interface

1. Press Menu→ Features→ Function Keys→ Line Keys as Function Keys→ Line Key2(for example)
2. Press  and  key to select the DTMF in the Type field.
3. Enter the Value field with the desired DTMF number.
4. Press  or Save soft key to save the configuration.

To configure the DTMF via Web interface



1. Click Function Keys→ Line Key.
2. Select the desired Line Key and select DTMF in the Type field.
3. Fill in the Value field with the desired DTMF number.
4. Click the to save the configuration.

Line	Type	Mode	Value	Label	Account	Extension
Key1	Line	Default		243	Account 1	
Key2	DTMF	Default	0012		Account 1	

Prefix

If the key is configured as Prefix key, you can set the number prefix (e.g. Before the number plus 9), then you don't input 9, press the key and 9 will display on the LCD interface.

To configure the Prefix via Phone interface

1. Press Menu→ Features→ Function Keys→ Line Keys as Function Keys→ Line Key2(for example)
2. Press  and  key to select the Prefix in the Type field.
3. Enter the value field with number that you want to set as prefix.
4. Press  or save soft key to save the configuration.

To configure the Prefix via Web interface:

1. Click Function Keys→ Line Key.
2. Select the desired Line Key and select Prefix in the Type field.
3. Fill in the value field with number that you want to set as prefix.
4. Click to save the configuration.



Then when you press this key, the set value is input directly.

Line	Type	Mode	Value	Label	Account	Extension
Key1	Line	Default		243	Account 1	
Key2	Prefix	Default	9		Account 1	

Local Group

When use the Local Group feature, press the key and enter the Local Contacts interface quickly.

To configure the Local Group via Phone interface

1. Press Menu→ Features→ Function Keys→ Line Keys as Function Keys→ Line Key2(for example)
2. Press  and  key to select the Local Group in the Type field.
3. Press  or Save soft key to save the configuration.

To configure the Local Group via Web interface

1. Click Function Keys→ Line Key.
2. Select the desired Line Key and select Local Group in the Type field.
3. Click to save the configuration.





Then you can press the Local Group key to quickly enter the Local Contacts interface.

Line	Type	Mode	Value	Label	Account	Extension
Key1	Line	Default		243	Account 1	
Key2	Local Group	Default			Account 1	

XML Group

When use the XML Group feature, press the key and enter the Remote Contacts interface quickly.

To configure the XML group via Phone interface

1. Press Menu→ Features→ Function→ Line Keys as Function Key→ Line Key2(for example)
2. Press  and  key to select the XML Group in the Type field.
3. Press  and  key to select the Account ID.

4. Press  or Save soft key to save the configuration.

To configure the XML Group via Web interface



1. Click Function Keys→ Line Key.
2. Select the desired Line Key and select XML Group in the Type field.
3. Select the desired remote phonebook in the Account field.
4. Click to save the configuration.

Line	Type	Mode	Value	Label	Account	Extension
Key1	Line	Default		243	Account 1	
Key2	XML Group	Default			remote pho	

XML Browser

You can use this key to access the Xml browser quickly. The Xml browser allows you to create custom services which meet your functional requirements on the server. You can customize practical applications, such as weather report, stock information, Google search, etc.

To configure the XML Browser via Phone interface

1. Press Menu→ Features→ Function Keys→ Line Keys as Function Keys→ Line Key2(for example)
2. Press  and  key to select the XML Browser in the Type field.
3. Fill in the access URL for xml browser in the Value field.
4. Press  or Save soft key to save the configuration.

To configure the XML Browser via Web interface





1. Click Function Keys→ Line Key.
2. Select the desired Line Key and select Xml Browser in the Type field.
3. Fill in the access URL for xml browser in the Value field. (e.g.: <http://10.2.0.140/XMLBrowser/TextMenu.xml>)
4. Click button to save the configuration.

Line	Type	Mode	Value	Label	Account	Extension
Key1	Line	Default		243	Account 1	
Key2	XML Browser	Default	http://10.2.0		Account 1	

Network Directories

When using the Broadsoft Directory feature, by just pressing the key you can enter the Broadsoft Contacts interface its fast and convenient.

To configure the Network Directories via Phone interface

1. Press Menu→ Features→ Function Keys→ Line Keys as Function Keys→ Line Key2(for example)
2. Press  and  key to select the BS Group in the Type field.
3. Press  and  key to select the Account ID.
4. Press  or Save soft key to save the configuration.

To configure the Network Directories via Web interface

1. Click Function Keys→ Line Key.
2. Select the desired Line Key and select Network Directories in the Type field.
3. Select the Account.
4. Click the button to save the configuration.

Line	Type	Mode	Value	Label	Account	Extension
Key1	Line	Default		243	Account 1	
Key2	Network Direct	Default			Account 1	

Then you can press the Network Directories key to quickly enter the Broadsoft Contacts interface.

To configure the Network Group via Web interface

1. Click Function Keys→ Line Key.
2. Select the desired Line Key and select Network Group in the Type field.
3. Select All Contacts/Group/Interoperability/GroupCommon/EnterpriseCommon/Personal/Custom Directories for the Account.
4. Click the button to save the configuration.



Line	Type	Mode	Value	Label	Account	Extension
Key1	Line	Default		243	Account 1	
Key2	Network Group	Default			All Contact	

Then you can press the Network Group key to quickly enter the selected secondary directory of Broadsoft Contacts.

Conference

The Htek IP Phone supports up to 5-way conference. You can configure the line key to be used as a conference key.

To configure the Conference via Phone interface

1. Press Menu→ Features→ Function Keys→ Line Keys as Function Keys→ Line Key2(for example)
2. Press  and  key to select the Conference in the Type field.
3. Press  or save soft key to save the configuration.

To configure Conference via Web interface

1. Click Function Keys→ Line Key.
2. Select the desired Line Key and select Conference in the Type field.
3. Click the button to save the configuration.

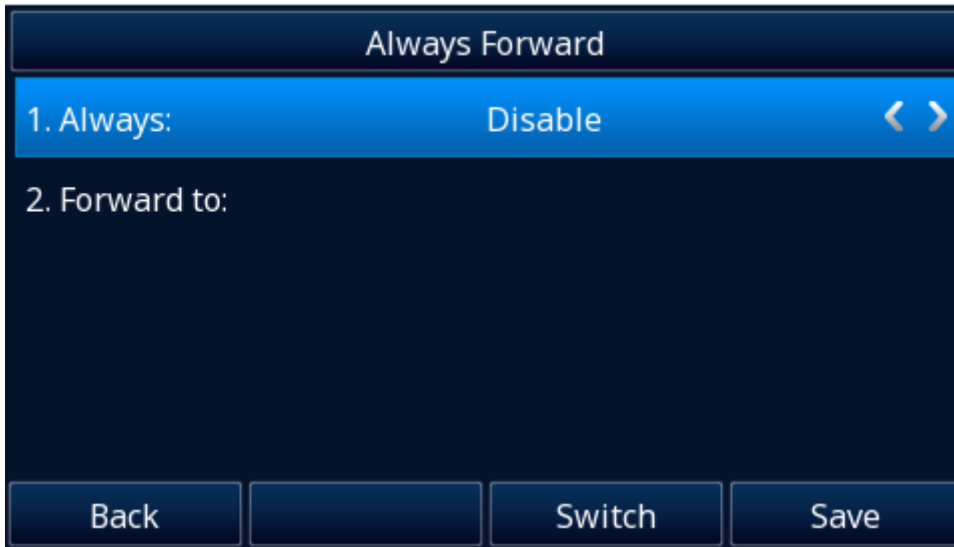

Line	Type	Mode	Value	Label	Account	Extension
Key1	Line	Default		243	Account 1	
Key2	Conference	Default			Account 1	

1. If the Forward Key has no configuration value, press it to enter the Always Forward configuration page.



2. If the forward key is configured with a value, please press this key to always turn it on, and this notification message will be displayed on the phone LCD. Press the forward key again to turn off this function. At this time, there is an incoming call, which can be dynamically forward.

To configure the Forward via Phone interface

1. Press Menu→ Features→ Function Keys→ Line Keys as Function Keys→ Line Key2(for example)
2. Press  and  key to select the Forward in the Type field.
3. Enter the Number to forward to in the Value field.
4. Press  or Save soft key to save the configuration.

To configure Forward via Web interface



1. Click Function Keys→ Line Key.
2. Select the desired Line Key and select Forward in the Type field.
3. Enter the Value field with the number you want to forward to.
4. Click the button to save the configuration.

Line	Type	Mode	Value	Label	Account	Extension
Key1	Line	Default		243	Account 1	
Key2	Forward	Default	245		Account 1	

Transfer

1. If the Transfer Key is configured with a value, then transfer will be executed directly, and it is related to [Transfer Mode via DSSkey](#).
2. If Transfer Key has no configuration value, it will be used as Transfer Softkey.

To configure the Transfer via Phone interface

1. Press Menu→ Features→ Function Keys→ Line Keys as Function Keys→ Line Key2(for example)
2. Press  and  key to select the Transfer in the Type field.
3. Enter the Number to transfer to in the Value field.
4. Press  or Save soft key to save the configuration.

To configure Transfer via Web interface



1. Click Function Keys→ Line Key.
2. Select the desired Line Key and select Transfer in the Type field.
3. Enter the Value field with the number that wanted transfer to
4. Click the  button to save the configuration.

Line	Type	Mode	Value	Label	Account	Extension
Key1	Line	Default		243	Account 1	
Key2	Transfer	Default	245		Account 1	

Hold

The key can be configured as a hold key. You can use this key to hold and resume a call during the conversation.

To configure the Hold via Phone interface

1. Press Menu→ Features→ Function Keys→ Line Keys as Function Keys→ Line Key2(for example)
2. Press  and  key to select the Hold in the Type field.
3. Press  or Save soft key to save the configuration.

To configure the Hold via Web interface

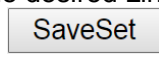

1. Click Function Keys→ Line Key.
2. Select the desired Line Key and select Hold in the Type field.
3. Click the  button to save the configuration.

Line	Type	Mode	Value	Label	Account	Extension
Key1	Line	Default		243	Account 1	
Key2	Hold	Default			Account 1	

DND

If the key is configured as DND key, allows you to activate the DND function immediately when you press it and the phone will reject all incoming calls automatically. Press it again to deactivate DND mode.

To configure the DND via Phone interface

1. Press Menu→ Features→ Function Keys→ Line Keys as Function Keys→ Line Key2(for example)
2. Press  and  key to select the DND in the Type field.

3. Press or Save soft key to save the configuration.

To configure DND via Web interface

1. Click Function Keys→ Line Key.
2. Select the desired Line Key and select DND in the Type field.
3. Click the button to save the configuration.

Line	Type	Mode	Value	Label	Account	Extension
Key1	Line	Default		243	Account 1	
Key2	DND	Default			Account 1	

To enable DND feature

Press the DND key when the phone is idle status, and then DND icon is shown on the LCD.

To disable DND feature

Press the DND key again, then there is no DND icon on the LCD.

Redial

If the key is configured as Redial key, you can redial the last placed call from the IP Phone.

To configure Redial via Phone interface

1. Press Menu→ Features→ Function Keys→ Line Keys as Function Keys→ Line Key2(for example)

2. Press and key to select the Redial in the Type field.

3. Press or Save soft key to save the configuration

To configure Redial via Web interface

1. Click Function Keys→ Line Key
2. Select the desired Line Key and select Redial in the Type field.
3. Click the button to save the configuration.

Line	Type	Mode	Value	Label	Account	Extension
Key1	Line	Default		243	Account 1	
Key2	Redial	Default			Account 1	

Record

With record feature, you can record your calls by pressing the record key.

To configure the Record via Phone interface

1. Press Menu→ Features→ Function Keys→ Line Keys as Function Keys→ Line Key2(for example)

2. Press and key to select the Record in the Type field.

3. Press or Save soft key to save the configuration.

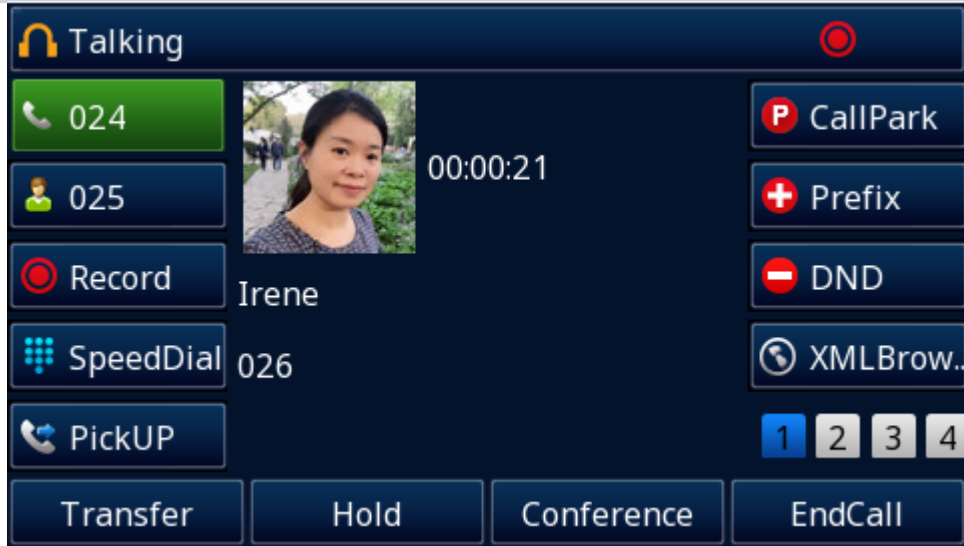

To configure the Record via Web interface

1. Click Function Keys→ Line Key.
2. Select the desired Line Key and select Record in the Type field.
3. Click the button to save the configuration.

Line	Type	Mode	Value	Label	Account	Extension
Key1	Line	Default		243	Account 1	
Key2	Record	Default			Account 1	

Note:

Please contact the system administrator whether support this feature or not.

URL Record

The phone sends HTTP URL request to trigger a recording. Contact your system administrator for the predefined URL.

To configure the URL Record via Phone interface

1. Press Menu→ Features→ Function Keys→ Line Keys as Function Keys→ Line Key2(for example)
2. Press and key to select the URL Record in the Type field.
3. Enter the predefined URL in the Value field.
4. Press or Save soft key to save the configuration.

To configure the URL Record via Web interface

1. Click Function Keys→ Line Key.
2. Select the desired Line Key and select URL Record in the Type field.
3. Fill in the predefined URL in the Value field.
4. Click the button to save the configuration.

Line	Type	Mode	Value	Label	Account	Extension
Key1	Line	Default		243	Account 1	
Key2	URL Record	Default	http://10.2.0		Account 1	





Note:

Please contact the system administrator whether support this feature or not.

Paging

With this feature, you can call a paging group directly.

To configure the Paging via Phone interface

1. Press Menu→ Features→ Function Keys→ Line Keys as Function Keys→ Line Key2(for example)
2. Press  and  key to select the Paging in the Type field.
3. Enter the paging code followed the number in the Value field.
4. Press  and  key to select the Account ID.
5. Press  or Save soft key to save the configuration.

To configure the Paging via Web interface

1. Click Function Keys→ Line Key.
2. Select the desired Line Key and select Paging in the Type field.
3. Enter the paging code followed the number in the Value field.
4. Select the Account.
5. Click the button to save the configuration.

Line	Type	Mode	Value	Label	Account	Extension
Key1	Line	Default		243	Account 1	
Key2	Paging	Default	*88039		Account 2	



Note:

Please contact the system administrator whether support this feature or not.

Group Listening

With this feature, when you have an active call, you can listen using Handset and speakerphone, but only can use the handset to speak.

To configure the Group Listening via Phone interface

1. Press Menu→ Features→ Function Keys→ Line Keys as Function Keys→ Line Key2(for example)
2. Press  and  key to select the Group Listening in the Type field.
3. Press  or Save soft key to save the configuration.

To configure the Group Listening via Web interface

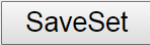

1. Click Function Keys→ Line Key.
2. Select the desired Line Key and select Group Listening in the Type field.
3. Click  to save the configuration.

Line	Type	Mode	Value	Label	Account	Extension
Key1	Line	Default		243	Account 1	
Key2	Group Listenin	Default			Account 1	

Public Hold

The key can be configured as a public hold key. During a conversation, all members belonging to that SLA group can use this key to hold or resume a call.

To configure the Public Hold via Phone interface

1. Press Menu→ Features→ Function Keys→ Line Keys as Function Keys→ Line Key2(for example)
2. Press  and  key to select the Public Hold in the Type field.
3. Press  or Save soft key to save the configuration.

To configure the Public Hold via Web interface

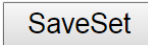
1. Click Function Keys→ Line Key.
2. Select the desired Line Key and select Public Hold in the Type field.
3. Click the  button to save the configuration.

Line	Type	Mode	Value	Label	Account	Extension
Key1	Line	Default		243	Account 1	
Key2	Public Hold	Default			Account 1	



Note:

Please contact the system administrator whether support this feature or not.

Private Hold

The key can be configured as a private hold key. During a conversation, all members belonging to that particular SLA group can use this key to hold the call, but only the initiator can resume the call.

To configure the Private Hold via Phone interface

1. Press Menu→ Features→ Function Keys→ Line Keys as Function Keys→ Line Key2(for example)
2. Press  and  key to select the Private Hold in the Type field.
3. Press  or Save soft key to save the configuration.

To configure the Private Hold via Web interface

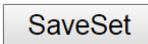
1. Click Function Keys→ Line Key.
2. Select the desired Line Key and select Private Hold in the Type field.
3. Click the  button to save the configuration.

Line	Type	Mode	Value	Label	Account	Extension
Key1	Line	Default		243	Account 1	
Key2	Private Hold	Default			Account 1	

Note:

Please contact the system administrator whether support this feature or not.

Zero Touch

You can use this key feature to configure auto provision and network parameters quickly.

Procedure

- Enter the zero touch screen (have two way, do one of the following)
 - Auto enter the zero touch screen when phone startup, you need enable zero touch active via web interface
web path: Management->Auto Provision->Firmware Upgrade->Zero Active

Zero Active No Yes

- Manual trigger by the Zero Touch key to enter the zero touch screen, You can set it via web interface or phone interface
 - To configure the Zero Touch via Phone interface
 - Press Menu→ Features→ Function Keys→ Line Keys as Function Keys→ Line Key2(for example)
 - Press and key to select the Zero Touch in the Type field.
 - Press or Save soft key to save the configuration.
 - To configure the Zero Touch via Web interface
 - Click Function Keys→ Line Key.
 - Select the desired Line Key and select Zero Touch in the Type field.
 - Click the button to save the configuration.

Line	Type	Mode	Value	Label	Account	Extension
Key1	Line	Default		243	Account 1	
Key2	Zero Touch	Default			Account 1	

- And you will see this



- Press the OK soft key and you can change network parameters in this page
Tip: temporary changes you made in this page will be saved in the last step

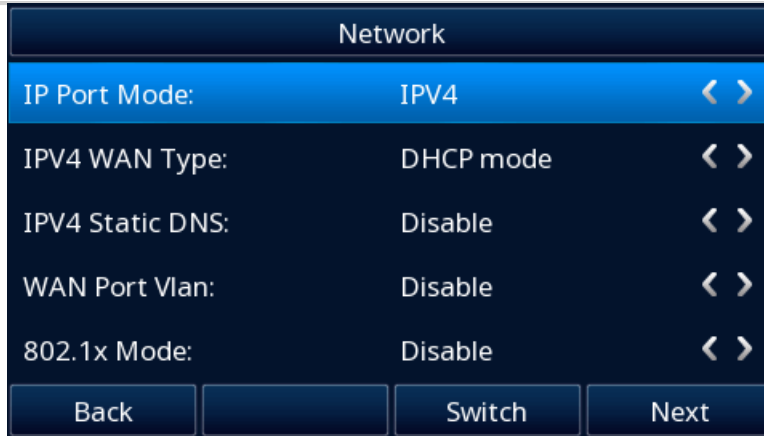

4. Press the Next soft key and you can change provision parameters in this page
 Tip: temporary changes you made in this page will be saved in the last step

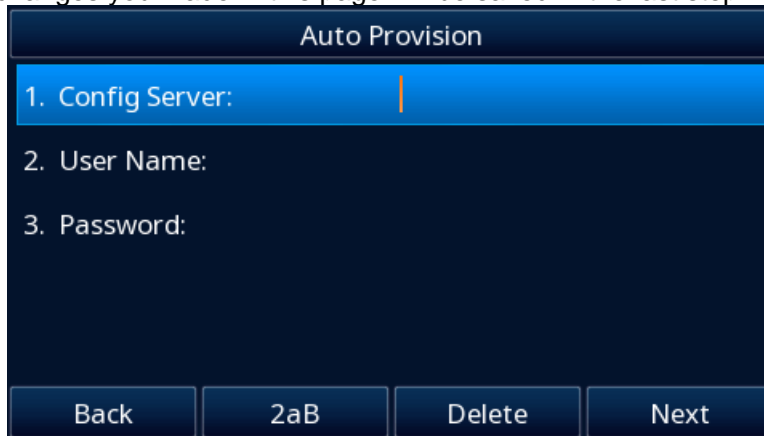

5. Press the Next soft key, save the above temporary configuration, then IP phone will connect to the configured provisioning server and perform auto provisioning.

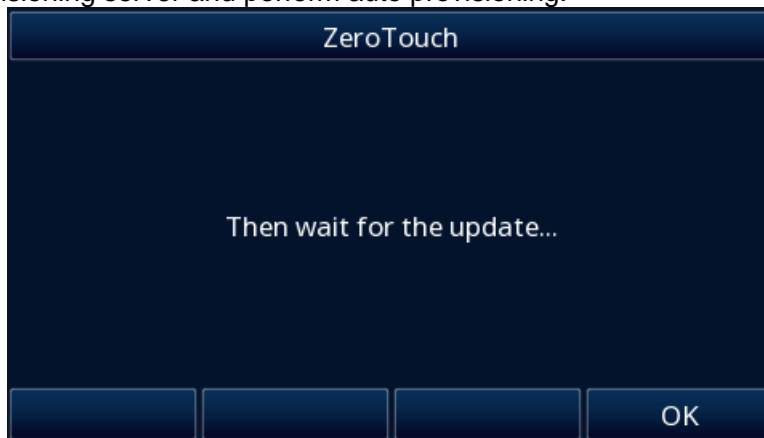



Multicast Paging

You can use multicast paging to forward out time sensitive announcements quickly and easily to people within the multicast group. You can configure a multicast paging key or a paging list key on the phone, which allows you to send a Real Time Transport Protocol (RTP) stream to the pre-configured multicast address/addresses without involving SIP signaling. You can configure the phone to receive an RTP stream from pre-configured multicast listening address/addresses without involving SIP signaling. You can specify up to 10 multicast listening addresses.

Sending RTP Stream

To configure a Multicast Paging key via Phone interface

1. Press Menu→ Features→ Function Keys→ Line Keys as Function Keys→ Line Key2(for example).
2. Press  and  or Switch soft key to select the Multicast Paging in the Type field.
3. Enter the multicast IP address and port number (e.g., 224.5.6.20:2000) in the Value field. The valid multicast IP addresses range from 224.0.0.0 to 239.255.255.255.
4. Press  or Save soft key to save the configuration.

To configure a Multicast Paging key via Web interface

1. Click Function Keys→ Line key:
2. Select the desired Line Key and select Multicast Paging in the Type field.
3. Enter the multicast IP address and port number (e.g., 224.5.6.20:2000) in the Value field. The valid multicast IP addresses range from 224.0.0.0 to 239.255.255.255.
4. Click the button to save the configuration.

Line	Type	Mode	Value	Label	Account	Extension
Key1	Line	Default		243	Account 1	
Key2	MultiCast Pagi	Default	224.5.6.20:2000		Account 1	

Sending RTP Stream:

Press the Multicast Paging key when the phone is idle.

The phone sends RTP to a preconfigured multicast address (IP: Port). Any phone in the local network then listens to the RTP on the preconfigured multicast address (IP: Port). For both sending and receiving of the multicast RTP, there is no SIP signaling involved.

The Multicast Paging key LED will be solid green.

Receiving RTP Stream

You can configure the phone to receive a Real Time Transport Protocol (RTP) stream from the pre-configured multicast address/addresses without involving SIP signaling. You can specify up to 10 multicast addresses that the phone listens to on the network.

How the phone handles incoming multicast paging calls depends on Paging Barge and Paging Priority Active parameters configured via web user interface.

Paging Barge

The paging barge parameter defines the priority of the voice call in progress. If the priority of an incoming multicast paging call is lower than that of the active call, it will be ignored automatically. If Disabled is selected from the pull-down list of Paging Barge, the voice call in progress will take precedence over all incoming multicast paging calls.

Valid values in the Paging Barge field:

- 1 to 10: Define the priority of the active call, 1 with the highest priority, 10 with the lowest.
- Disabled: The voice call in progress will take precedence over all incoming paging calls.

Paging Priority Active

The paging priority active parameter decides how the phone handles incoming multicast paging calls when there is already a multicast paging call on the phone. If enabled, the phone will ignore incoming multicast paging calls with lower priorities, otherwise, the phone will answer incoming multicast paging calls automatically and place the previous multicast paging call on hold. If disabled, the phone will automatically ignore all incoming multicast paging calls.

Multicast Codec

You can only configure the codec via Web interface.

To configure Multicast Codec via Web interface

1. Click Directory→ Multicast Paging
2. Select the desired codec from the pull-down list of Multicast Codec

3. Click the button to save the configuration.

Listening Address

To configure multicast listening addresses via Web interface:

1. Click Directory→ Multicast Paging.
2. Select the desired value from the pull-down list of Paging Barge.
3. Select the desired value from the pull-down list of Paging Priority Active.
4. Enter the multicast IP address and port number (e.g., 224.5.6.20:2000) which the phone listens to for incoming RTP multicast in the Listening Address field.
5. Enter the label in the Label field.
6. Click button to save the configuration.

Paging Barge

Paging Priority Active

Multicast Codec

Index	Listening Address	Label	Multi Priority
IP Address 1	<input type="text" value="224.5.6.20:2000"/>	<input type="text"/>	1
IP Address 2	<input type="text"/>	<input type="text"/>	2
IP Address 3	<input type="text"/>	<input type="text"/>	3
IP Address 4	<input type="text"/>	<input type="text"/>	4
IP Address 5	<input type="text"/>	<input type="text"/>	5
IP Address 6	<input type="text"/>	<input type="text"/>	6
IP Address 7	<input type="text"/>	<input type="text"/>	7
IP Address 8	<input type="text"/>	<input type="text"/>	8
IP Address 9	<input type="text"/>	<input type="text"/>	9
IP Address 10	<input type="text"/>	<input type="text"/>	10

Note:

The priorities of listening to multicasting addresses can be predefined: 1 being the highest priority, 10 with the lowest in priority order. Both the multicast paging sender and receiver's phones play a warning tone when establishing a multicast paging call. Listening to Multicasting addresses can be configurable via Web interface only.

Soft Keys, Navigation Keys and Hard Keys are Programmable. You can define them as some other features rather than the default in idle status. And please note that if the blank is gray, it means that the type is not editable.

Customizing the Soft Keys

You can customize the soft key functions displayed at the bottom of the phone screen. These soft keys are usually used to access frequently used functions and create menu shortcuts to access frequently used phone settings.

To configure the soft keys via Web interface:

1. Click webpage → Function keys → Programmable Key → softkey.
2. Select the desired softkey(softkey1-4)
3. Select the desired key type from the Type field.
4. (Optional.) Enter the string that will appear on the phone screen in the label field.
5. (Optional.) Select the desired line from the Account ID field.
6. (Optional.) Enter the corresponding value in the Value field.
7. Click button to save the configuration.

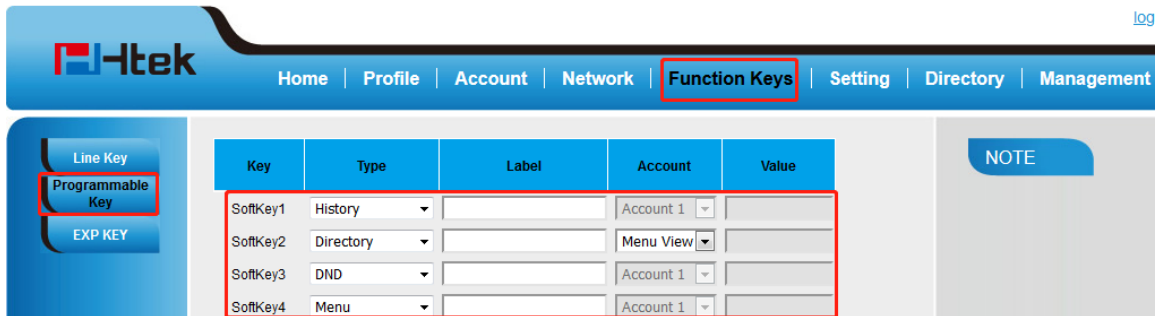

Key	Type	Label	Account	Value
SoftKey1	History		Account 1	
SoftKey2	Directory		Menu View	
SoftKey3	DND		Account 1	
SoftKey4	Menu		Account 1	

LCD display:



Note:

We recommend that you keep a Menu soft key, otherwise you cannot access the phone settings.

Customizing the hard Keys

You can customize the hard keys on the phone, such as navigation keys, volume keys, voicemail, headset, mute, Speaker, conference, HOLD, transfer.

To configure the hard keys via Web interface:

1. Click webpage → Function keys → Programmable Key
2. Select the desired key.
3. Select the desired key type from the Type field.
4. (Optional.) Select the desired line from the Account ID field.
5. (Optional.) Enter the corresponding value in the Value field.
6. Click button to save the configuration.

Key	Type	Account	Value
Up	History	Account 1	
Down	Directory	Menu View	
Left	Switch Account Up	Account 1	
Right	Switch Account Down	Account 1	
OK	Status	Account 1	
Cancel	N/A	Account 1	
MUTE	N/A	Account 1	
CONF	N/A	Account 1	
TRAN	Forward	Account 1	
HOLD	N/A	Account 1	
Speaker	Speaker	Account 1	
Headset	Headset	Account 1	
VM	VM	Account 1	
Volume Up	Volume Up	Account 1	
Volume Down	Volume Down	Account 1	

Note:

We recommend that you keep a Menu soft key, otherwise you cannot access the phone settings.

Exp Key

When the extension module is turned on, the configuration items will be displayed (Only **UC926U(S)** **UC926(E)** and **UC924U(W)** **UC924(E)** support).

To configure the soft keys via Web interface:

1. Click webpage → Function keys → EXP KEY
2. Select the desired Expansion Key (Expansion1-Expansion6)
3. Select the desired key type from the Type field.

4. (Optional.) Enter the string that will appear on the phone screen in the label field.
5. (Optional.) Select the desired line from the Account ID field.
6. (Optional.) Enter the corresponding value in the Value field.
7. Click button to save the configuration.
8. (Optional) Click NextPage/PrePage button to turn the page.

For detailed information about expansion modules, refer to [Expansion module](#).

Customizing Your Phone

Administrator Password

The password is mainly used for login the web interface or set the advanced settings through phone interface. And the default password of the administrator is: **admin**.

To change to password via phone interface

1. Press Menu→ Settings→ Advanced setting→ Password (default: admin) → Phone Setting → set Password
2. Enter the Current PWD (password), New PWD and confirm the new password.
3. Press Save soft key or to save the new password.

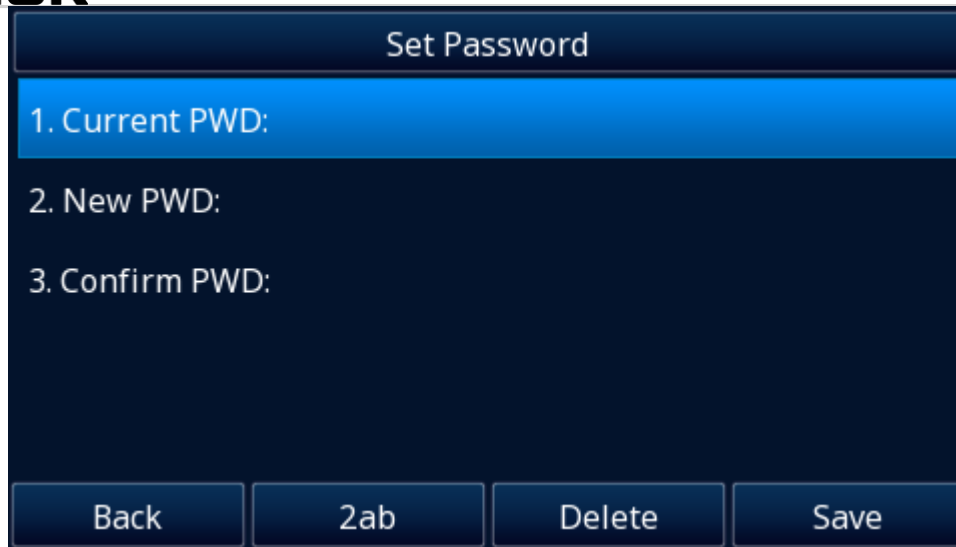

The image shows a 'Set Password' dialog box with a dark blue background. At the top, the title 'Set Password' is centered. Below the title, there are three numbered prompts: '1. Current PWD:', '2. New PWD:', and '3. Confirm PWD:'. Each prompt is followed by a corresponding input field. At the bottom of the dialog, there are four buttons: 'Back', '2ab', 'Delete', and 'Save'.

To change to password via Web interface

1. Management→ Password
2. Fill in the value (Maximum length of Current Password/New Password/Confirm Password)
3. Click to save the configuration.

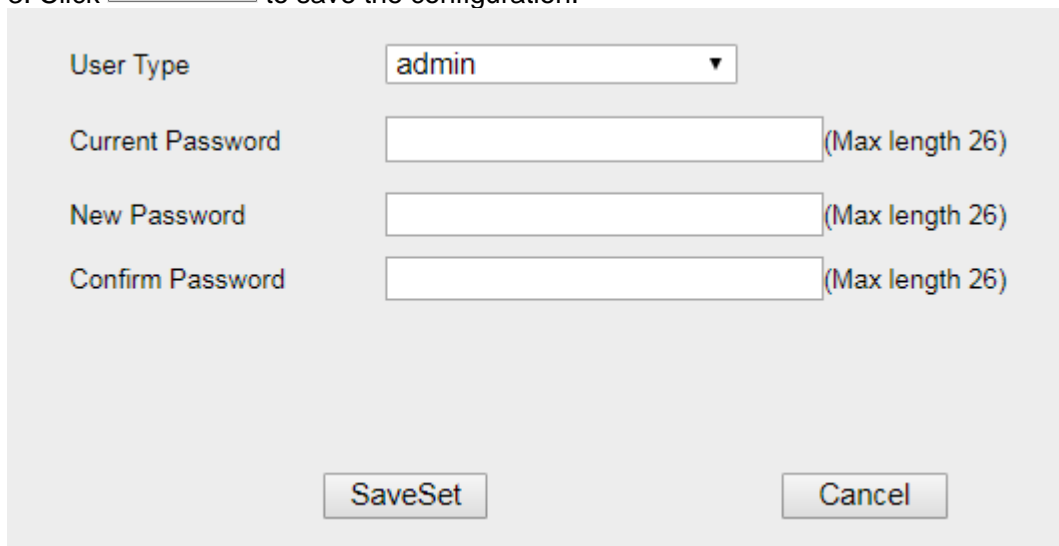

The image shows a web interface form for changing a password. It has a light gray background. At the top, there is a 'User Type' dropdown menu with 'admin' selected. Below this are three text input fields: 'Current Password', 'New Password', and 'Confirm Password'. Each input field has a '(Max length 26)' label to its right. At the bottom of the form, there are two buttons: 'SaveSet' and 'Cancel'.

Note:
When you use the web interface, default:
username: admin
password: admin

Language

The default Phone interface language is English.

To change the language via Phone interface

1. Press Menu→ Settings→ Basic Setting→ Language.
2. Select the necessary one.
3. Press  or Save soft key to save the configuration.

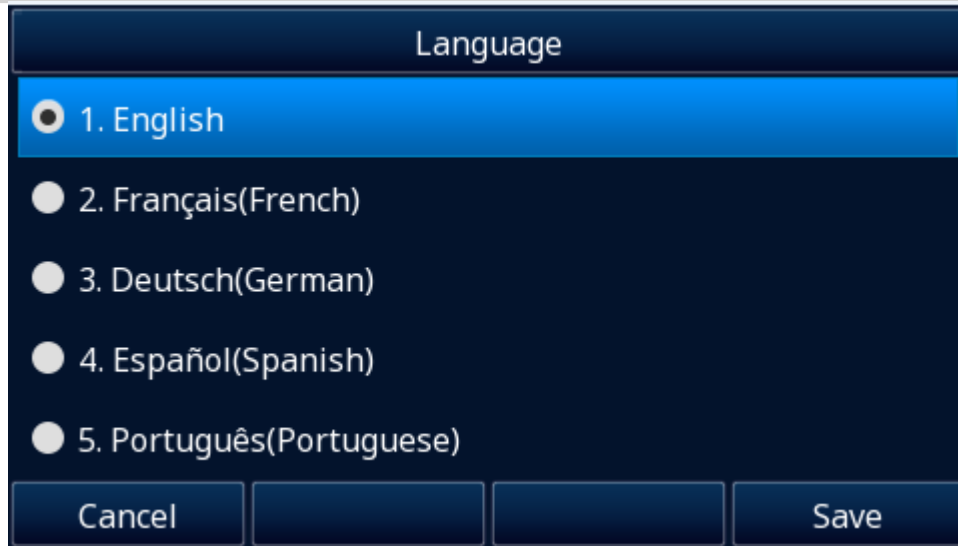

To change the language via Web interface

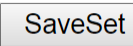
1. Setting→ Preference→ Web Language & LCD Language
2. Select the necessary one.
3. Press  to save the configuration.

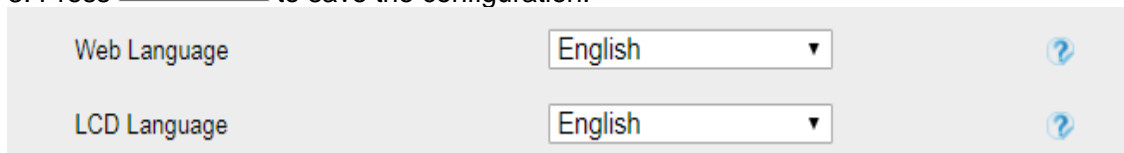



Note:

All languages may not be available for selection. The available languages depend on the language packs currently loaded to the IP phone.

Wallpaper

To change wallpaper, go by the following steps:

To change the wallpaper via Phone interface:

1. To press Menu→ Display→ Wallpaper
2. Press  and  or press Switch soft key to display the different pictures.
3. Press  or Save soft key to save the selected picture as the wallpaper.



To change the wallpaper via Web interface:

1. Click Setting→ Preference
2. Select the desired wallpaper picture to upload.
3. Click to save the setting.

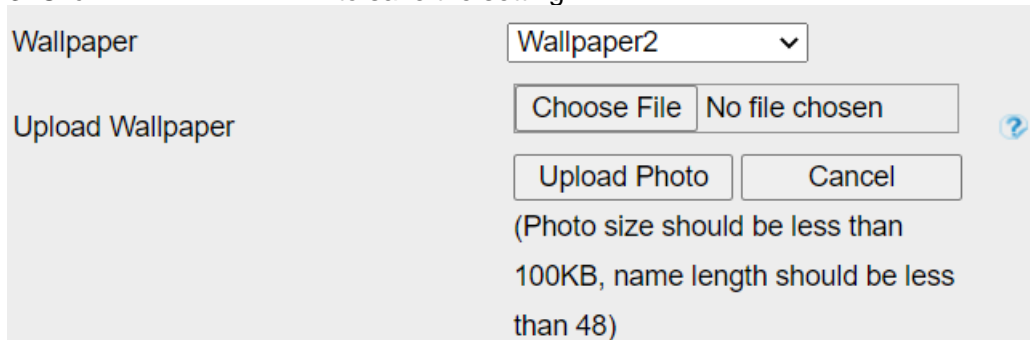

To delete the wallpaper via Web interface:

1. Click Setting→ Preference
2. Select the desired wallpaper to delete.
3. Click to save the setting.

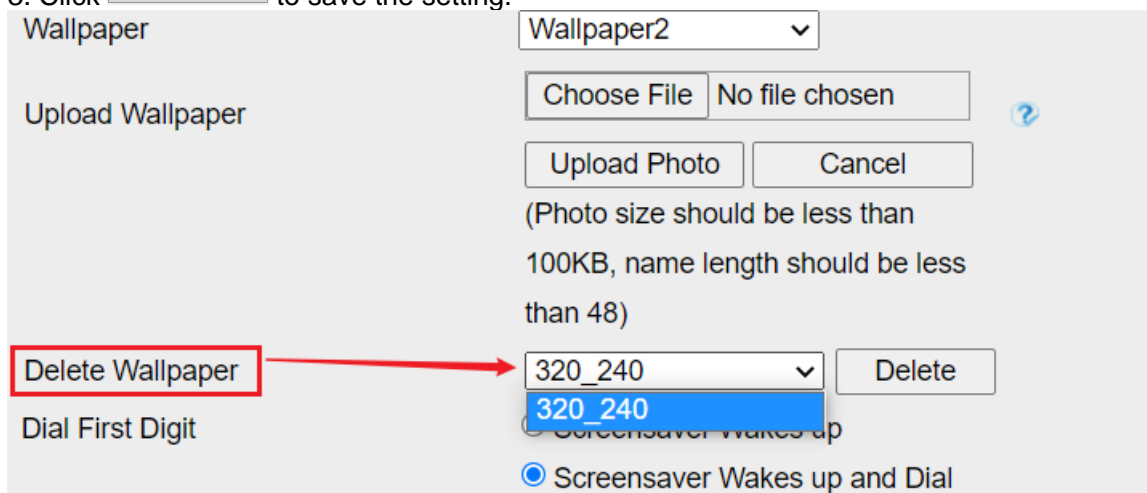

Note:

System wallpaper (Wallpaper1-Wallpaper3) cannot be deleted and only color Phone support upload wallpaper (Default: Wallpaper2).

There are four types of screen saver: Time & Logo, Time Only, Photo Switch and Static Photo.

Time & Logo: when the screensaver works, it will show Time and logo in turns.

Time Only: when the screensaver works, it will only show Time





Photo Switch: all screensaver pictures display one by one.

Static Photo: Only the selected picture will display as screensaver.

Text Logo: It works with the **Time & Logo**, when enter the value, it will display the time and the entered value in turns.

To enable screen saver via Phone interface:

1. To press Menu→ Display→ Screensaver.

2. Press  and  or press Switch soft key or press  and press  and  to choose the Screensaver as 1 minute or 2/5/10/30 minutes.

3. Press Save soft key to save the selected configuration.



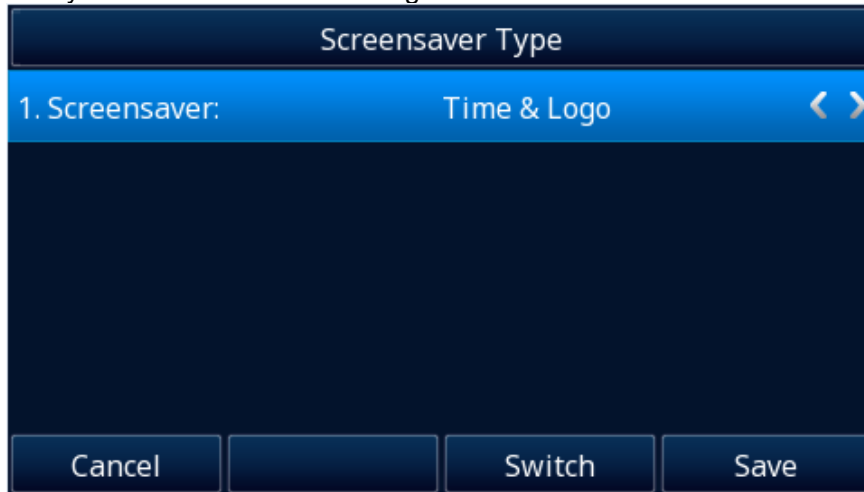

4. Press Menu→ Display→ Screensaver → ScreenSaver Type and Enter soft key to enter Screensaver type, choose the Screensaver: Time & Logo, Time Only, Photo Switch and Photo.

5. Press Save soft key to save the selected configuration.



To disable screen saver via Phone interface

1. To press Menu→ Display→ Screensaver...

2. Press  and  or press Switch soft key or press  and press  and  to choose the Screensaver as off.

3. Press  or Save soft key to save the selected configuration.

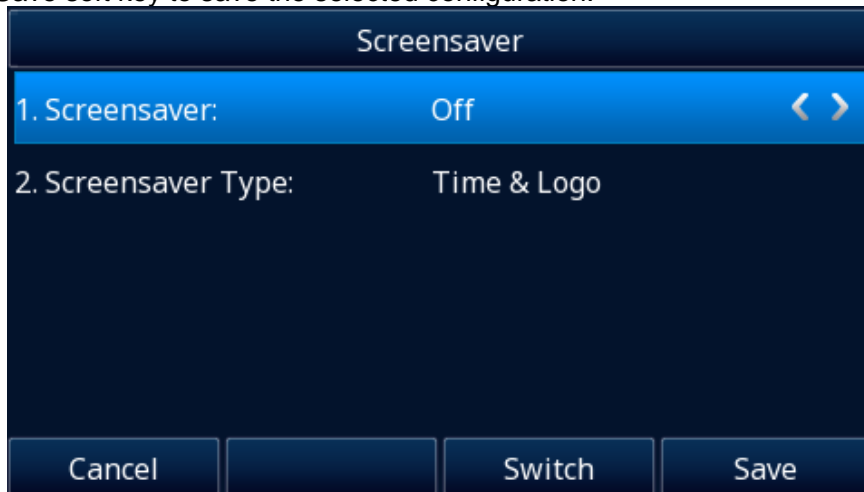

To upload screen saver via Web interface:

1. Setting→ Preference
2. Choose the picture wanted to use as screen saver
3. Click to save the upload picture

ScreenSaver Type: time & logo

Upload Screen Photo: Choose File (No file chosen), Upload Photo, Cancel

(Photo size should be less than 100KB, name length should be less than 48)

ScreenSaver Photo: [Dropdown], Delete

To delete upload screen saver photo via Web interface:

1. Setting→ Preference
2. Select the photo that to delete.
3. Click to delete the photo.

ScreenSaver Type: time & logo

Upload Screen Photo: Choose File (No file chosen), Upload Photo, Cancel

(Photo size should be less than 100KB, name length should be less than 48)

ScreenSaver Photo: [Dropdown], Delete

Note:

System Screen Photo (ScreenSaver1-ScreenSaver3) cannot be deleted and only color IP Phone support upload wallpaper.

To custom text logo via Web interface:

1. Click Setting→ Preference.
2. Choose the Screen Time Out as 1 min or 2/5/10/30 minute and choose the ScreenSaver Type as time & logo.
3. Enter the desired value in the Text Logo field.
4. Click to save the configuration.

Screen Time Out: off

Text Logo: [Empty Field]

ScreenSaver Type: time & logo

it will work when screensaver type is time & logo or logo only, and \";' represents the newline

To wake up screen saver via Web interface:

1. Setting→ Preference
2. Choose Dial First Digit: Screensaver Wakes up or Screensaver Wakes up and Dial
3. Click to save the configuration.

Dial First Digit

- Screensaver Wakes up
- Screensaver Wakes up and Dial

Note:

1. The upload Photo size should be less than 100KB, name length should be less than 48 characters, and the File name should be letters, numbers, or underline '_' and photo number should be less than 9.
2. The default screensaver photos cannot be deleted.
3. You can only upload screen photos in format of '.bmp' and '.jpg'.

Backlight

To set Backlight via Web interface:

1. Click Setting→ Preference
2. Enter the time for Backlight time (In seconds).
The default is 0, which means Backlight is always on.
3. Click to save the configuration.

Backlight Time



Note:

Backlight Time refers to the time into the backlight.

Time and Date

Time and date is displayed on the idle page, and it can be set automatically by SNTP server or manually by manual setting.

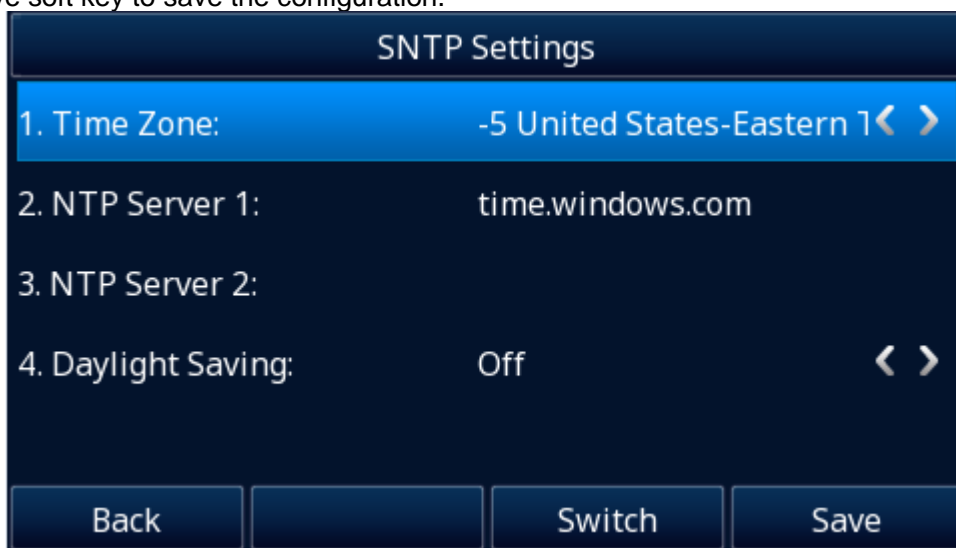

To configure the time and Date by SNTP setting via Phone interface

1. Press Menu→ Settings→ Basic Setting→ Time & Date→ SNTP Settings
2. Press or or Switch soft key or press and press and to change the Time zone.
3. Fill in the NTP Server1, NTP Server2, and select the mode of Daylight Saving.
4. Press Save soft key to save the configuration.









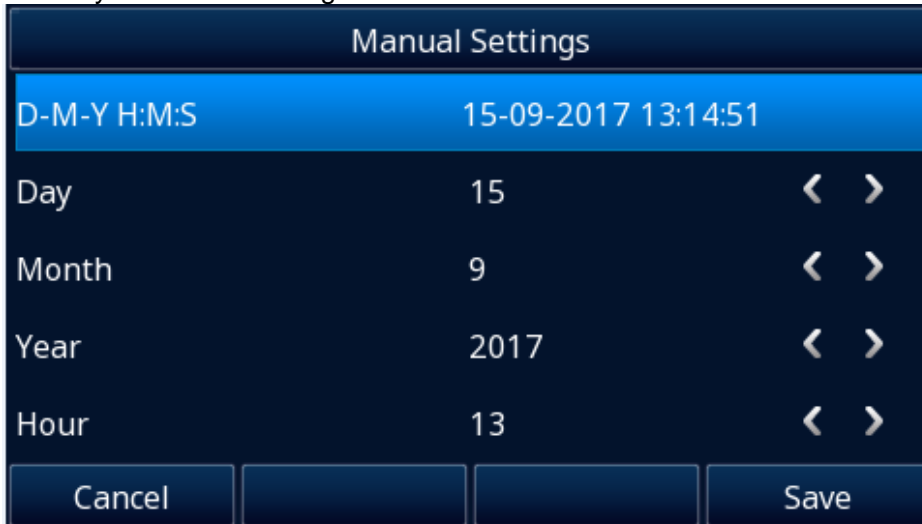



To configure time and date manually via Phone interface

1. To press Menu→ Settings→ Basic Setting→ Time & Date→ Manual

2. Press  and  to change the right time, or you can input the right time.
3. Press Save soft key to save the configuration.





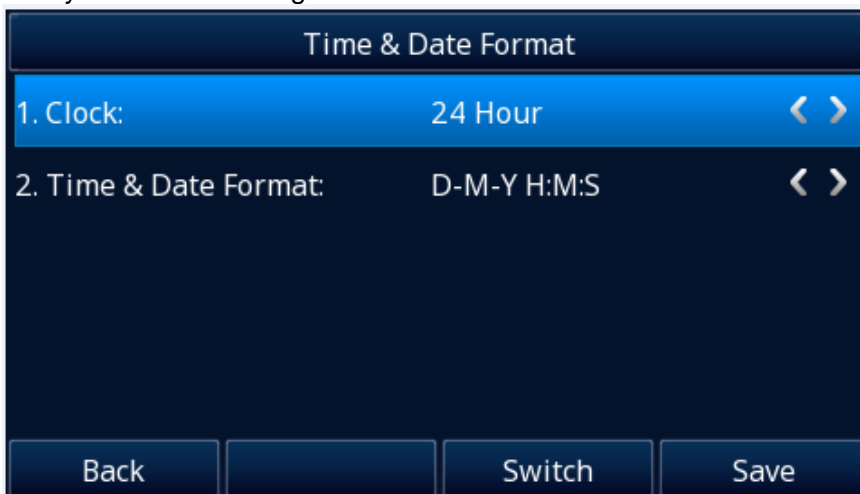

To configure the Time & Date Format via Phone interface

1. Press Menu→ Settings→ Basic Setting→ Time & Date Format
2. Press  and  or Switch soft key or press  and press  and  to change between 12 Hour or 24 Hour time display.
3. Press  and  or Switch soft key or press  and press  and  to change date display format.
4. Press Save soft key to save the configuration.



To configure the DHCP time via Phone interface

1. To press Menu→ Settings→ Basic Setting→ DHCP time
2. Press  and  or Switch soft key or press  and press  and  to change between Disable and Enable.
3. Press Save soft key to save the configuration.

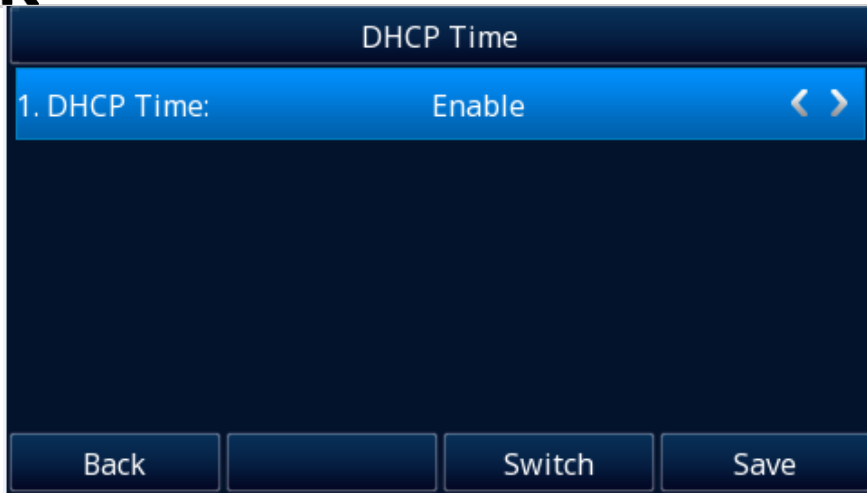

To configure the DHCP Option 100 via Web interface:

1. Log into the webpage (default username: admin, password: admin)
2. Setting→ Date & Time→ DHCP Option 100
3. Select Yes for the DHCP Option 100
4. Click to save the configuration.

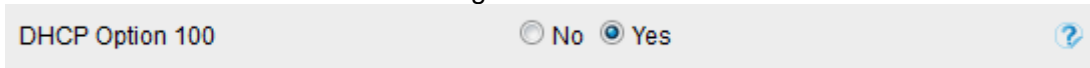

To configure the NTP Server via Web interface

1. Log into the webpage (default username: admin, password: admin)
2. Setting→ Date & Time→ NTP Server
3. Fill in the value in the blank.
4. Click to save the configuration.

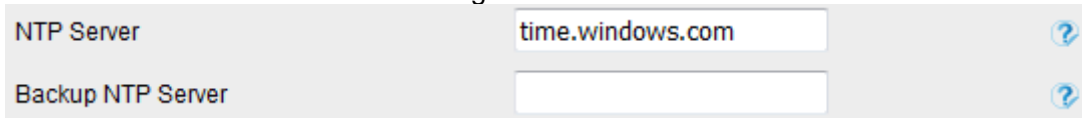

To change the Time Zone and Date Display Format via Web interface

1. Setting→ Date & Time
2. Select the necessary one.
3. Click to save the configuration.

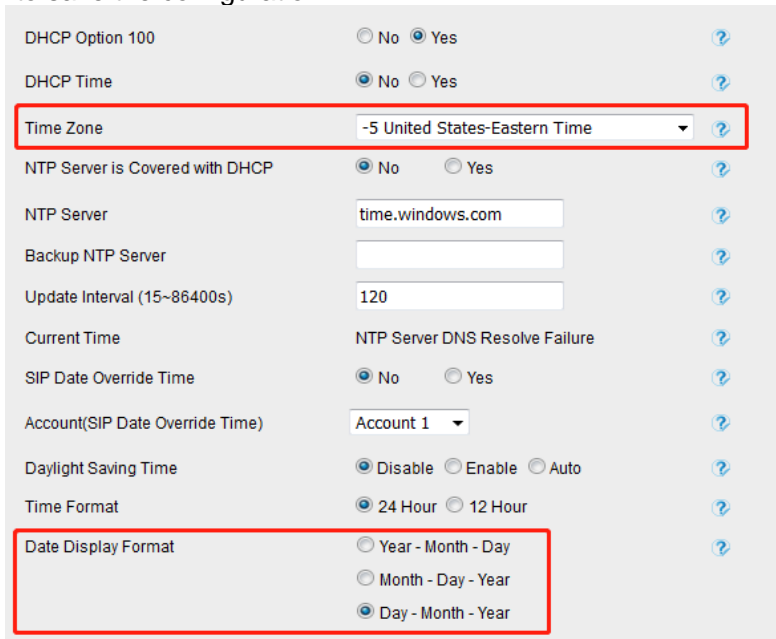



To change the SIP Date Override Time via Web interface

1. Setting→ Date & Time→ SIP Date Override Time

2. Select Yes or No for SIP Date Override Time.

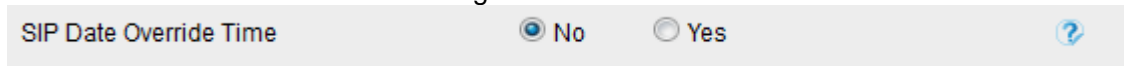
3. Click  to save the configuration.



SIP Date Override Time No Yes 

To change the Account via Web interface

1. Setting→ Date & Time→ Account.

2. Select Yes for SIP Date Override Time and select desired Account.

3. Click  to save the configuration.

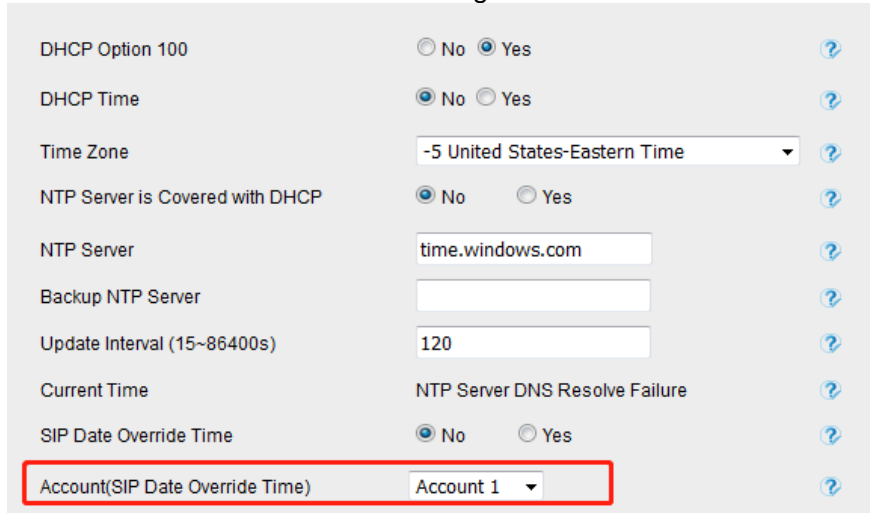



DHCP Option 100 No Yes 

DHCP Time No Yes 

Time Zone 

NTP Server is Covered with DHCP No Yes 

NTP Server 

Backup NTP Server 

Update Interval (15~86400s) 

Current Time NTP Server DNS Resolve Failure 

SIP Date Override Time No Yes 

Account(SIP Date Override Time) 

To change the Daylight Saving Time via Web interface

1. Setting→ Date & Time→ Daylight Saving Time

2. Select Disable or Enable or Auto for Daylight Saving Time.

3. Click  to save the configuration.

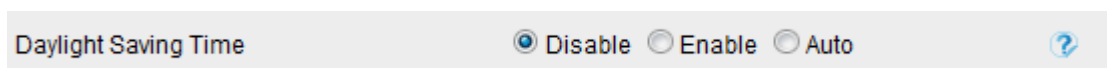

Daylight Saving Time Disable Enable Auto 

Note:

If the IP Phone cannot obtain the time and date from the Simple Network Time Protocol (SNTP) server, please contact your system administrator for more information.

Daylight Saving Time

Daylight Saving Time (DST) is the practice of temporary advancing clocks during the summertime so that evenings have more daylight and mornings have less. Typically, clocks are adjusted forward one hour at the start of spring and backward in autumn. Many countries have used the DST at various times, details vary by location. The DST can be adjusted automatically from the time zone configuration. Typically, there is no need to change this setting.

LED Status Setting

The LED Status setting mainly defines the power indicator LED.

To configure LED Status via Web interface:

1. Click Setting→ Preference

2. Select Yes or No for Power Status, Ringing Status, Miss Calls Status, Voice Message Status and Active Call Status.

3. (optional) Select LED Flash speed and LED Light color.

4. Click  for the setting.

For the LED status description, see LED Instruction [Power Indicator LED](#)

LED Status Setting:

Power Status	<input checked="" type="radio"/> Yes <input type="radio"/> No
LED Flash speed	ON
LED Light color	Green
Ringing Status	<input checked="" type="radio"/> Yes <input type="radio"/> No
LED Flash speed	Fast
LED Light color	Red
Miss Calls Status	<input type="radio"/> Yes <input checked="" type="radio"/> No
LED Flash speed	Fast
LED Light color	Red
Voice Message Status	<input type="radio"/> Yes <input checked="" type="radio"/> No
LED Flash speed	Slow
LED Light color	Red
Active Call Status	<input type="radio"/> Yes <input checked="" type="radio"/> No
LED Flash speed	Slow
LED Light color	Red

Key as Send

To configure # as Send Key via Phone interface:

1. Press **Menu** → **Features** → **# as Send Key**
2. Switch the option to **Enable**.
3. Press **Save** soft key.

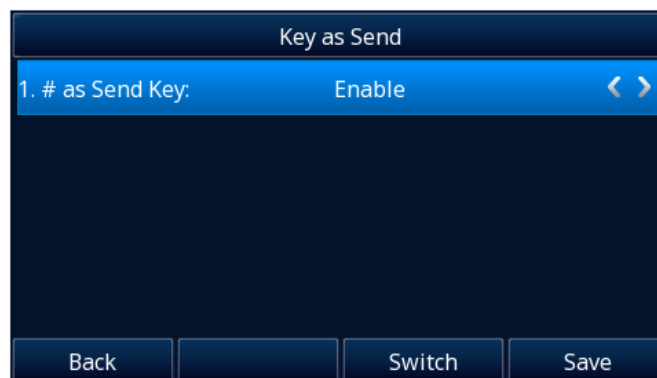

To cancel # as Send key via Phone interface:

1. Press **Menu** → **Features** → **# as Send key**
2. Switch the option to **Disable**.
3. Press **Save** soft key to save the configuration.

To configure # as Send key via Web interface:

1. Click **Setting** → **Preference**.

2. Select Yes or No for **Use # As Dial Key**.
3. Click **SaveSet** for the setting.

Use # As Dial Key

No

Yes



Dial Plan

Dial plan is a string of characters that governs the way this phone processes the inputs received from your phone keypad. This phone supports dial plan with following accepts digits:

1,2,3,4,5,6,7,8,9,0, *, #

Grammar	Description
x	any digit from 0-9;
xx+	at least 2-digit number;
^	exclude;
,	hear dial tone;
[3-5]	any digit of 3, 4, or 5;
[147]	any digit 1, 4, or 7;
<2=011>	replace digit 2 with 011 when dialing.

To configure dial plan via Web interface:

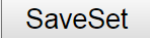
1. Click Account→ Basic.
2. Select the desired account from the pull-down list of Account in the Account field.
3. Fill in the value in Dial Plan field (Maximum length 1024).
4. Click  to save the configuration.





Account	Account 1	
Account Status	025@10.13.0.12:5060 : Registered; UDP	
* Account Active	<input type="radio"/> No	<input checked="" type="radio"/> Yes
Profile	Profile 1	
Label	<input type="text"/>	?
* SIP User ID	025	?
* Authenticate ID	025	?
* Authenticate Password	●●●●●●●●	?
Name	<input type="text"/>	?
Local SIP Port	5060	?
Use Random Port	<input checked="" type="radio"/> No	<input type="radio"/> Yes
Voice Mail UserID	<input type="text"/>	?
Dial Plan	{[x*]+}	
Eventlist BLF URL	<input type="text"/>	
Shared Line	Disable	
SCA Barge-In	Disable	?
Direct Call Pickup Code	<input type="text"/>	
Group Call Pickup Code	<input type="text"/>	
Feature Key Sync	Disable	

Note:

1. Illegal input will fall back to default: {[x*]+}, illegal characters refer to all characters not within {}.
2. If the number you entered does not match the dial plan, you will not be able to make outgoing calls.

Phone Lock

To enable Keypad Lock via Phone interface:

1. Press Menu → Settings → Advanced Setting → Phone Setting → keypad Lock
2. Press ,  key or Switch soft key or press  and press  and  to change selected lock type:
All keys, Menu Key, Function Key, Lock & Answer
3. Press Save soft key to save the configuration.

To disable Keypad Lock via Phone interface:

1. Press Menu → Settings → Advanced Setting → Phone Setting → keypad Lock

2. Press and key or Switch or press and press and to change to choose Disable.
3. Press Save to save the configuration.

To enable Keypad Lock via Web interface:

1. Click Setting→ Features→ Phone Lock
2. To choose All Keys, Menu Key, or Function Keys for the Keypad Lock.
3. Fill in the Phone Unlock Pin and Auto Lock Time-Out.
4. Fill in the Emergency number. When the phone is Lock, only Emergency number can be sent.
5. Click to save the configuration.

Phone Lock	
Keypad Lock	All Keys
Phone Unlock Pin(0~15digital)
Auto Lock Time-Out(15~3600s)	15
Emergency	110

To Disable Keypad Lock via Web interface:

1. Click Setting→ Features→ Phone Lock
2. Choose Disable for the Keypad Lock.
3. Click to save the configuration.

Emergency Call

Public telephone networks in countries around the world have a single emergency telephone number (emergency services number), that allows a caller to contact local emergency services for assistance when required. The emergency telephone number may differ from country to country. It is typically a three-digit number that can be easily remembered and dialed quickly. Some countries have a different emergency number for each of the different emergency services.

You can specify the emergency telephone numbers on the Desk Phone for contacting the emergency services in an emergency.

To configure emergency call via Web interface:

1. Click Setting→ Features→ Phone Lock
2. Enter the emergency services number in the Emergency field (maximum length 63).
3. Click to save the configuration.

Phone Lock	
Keypad Lock	All Keys
Phone Unlock Pin(0~15digital)
Auto Lock Time-Out(15~3600s)	15
Emergency	110

Note: If multiple emergency calls are configured, they can be separated by commas. For example: 110,119,120.

To configure action URL via Web interface:

1. Click Setting→ Action URL
2. Fill in the needed values in the designated blank spaces.
3. Click to save the configuration.





Setup Completed	<input type="text"/>	?
Log On	<input type="text"/>	?
Log Off	<input type="text"/>	?
Register Failed	<input type="text"/>	?
Off Hook	<input type="text"/>	?
On Hook	<input type="text"/>	?
Incoming Call	<input type="text"/>	?
Outgoing Call	<input type="text"/>	?
Call Established	<input type="text"/>	?
Call Terminated	<input type="text"/>	?
Open DND	<input type="text"/>	?
Close DND	<input type="text"/>	?
Open Always Forward	<input type="text"/>	?
Close Always Forward	<input type="text"/>	?

Open Busy Forward	<input type="text"/>	?
Close Busy Forward	<input type="text"/>	?
Open No Busy Forward	<input type="text"/>	?
Close No Busy Forward	<input type="text"/>	?
Transfer Call	<input type="text"/>	?
Blind Transfer call	<input type="text"/>	?
Attended Transfer Call	<input type="text"/>	?
Hold	<input type="text"/>	?
Unhold	<input type="text"/>	?
Mute	<input type="text"/>	?
Unmute	<input type="text"/>	?
Missed Call	<input type="text"/>	?
Idle To Busy	<input type="text"/>	?
Busy To Idle	<input type="text"/>	?
Forward Incoming Call	<input type="text"/>	?
Reject Incoming Call	<input type="text"/>	?
Answer New Incoming Call	<input type="text"/>	?
Transfer Finished	<input type="text"/>	?
Transfer Failed	<input type="text"/>	?

Softkey Layout

This feature mainly defines which shown on the soft key in some status. For example, what the soft key displays when dialing, or talking.

To configure Soft key via Web interface:

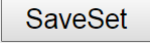
1. Click Setting→ Softkey Layout
2. Select Enable for Custom Softkey
3. Select Call States.
4. Select the feature from the Disable Keys to Enable Keys field by . moves the Disable key to Enable field.  moves the Enable key, and it will back Disable field.
5. Click  or  to change to position for each feature.
6. Click  to save the configuration.

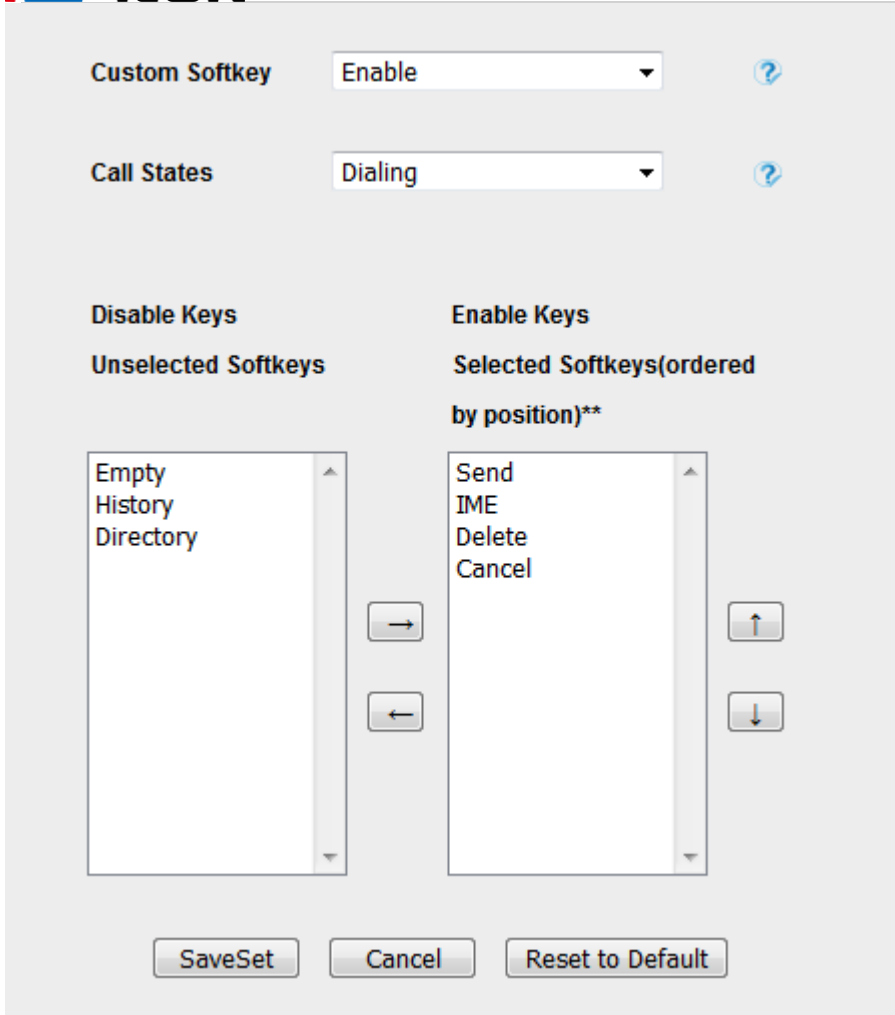

Note:

When there are more than 5 items in the Enable field, the last soft key will display More, and last two item will show on the next page of soft key, you can check by press More.

Settings

General settings

Dial-Now Timeout

Dial-Now Timeout means that when you enter the number which is matching with dial plan, it will dial out automatically after some time when you stop entering the number.

To configure Dial-Now Timeout via Web interface:

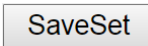
1. Click Setting→ Preference
2. Fill the blank of Dial-Now Timeout: for example, 5(seconds).
0 means dial out immediately, default is 0 seconds, max is 29 seconds (between 0 to 29).
3. Click the  button to save the configuration.

Dial-now Time-out (seconds)

5



No Key Entry Timeout

No Key Entry Timeout means that when you enter the number, it will dial out automatically after some time when you stop enter the number.

To configure No Key Entry Timeout via Web interface:

1. Click Setting→ Preference
2. Fill the blank of No Key Entry Timeout: for example, 5(seconds).
In seconds,0 means will not timeout, you should press the Dial key to dial out the number, default is 0 seconds, max is 29 seconds (between 0 to 29).
3. Click the button to save the configuration.

NO Key Entry Timeout(seconds)

5



Label Scroll

When setting function keys, you need to set the label of the function keys. If the words are too long to show on the label, you can use this function to make labels scroll. Another approach is to set the labels to Long Label mode.

To configure Label Scroll via Web interface:

1. Click Setting→ Preference
2. Select Enable or Disable for Label Scroll.
3. Click for the setting.

Lable Scroll

Enable



Show Missed Calls

Whether to show missed call notification on LCD.

After turning off this function, all missed calls will not be displayed. If there are missed calls after turning it on again, the total number of missed calls during turning off and after turning on again will be displayed.



Note:

1. If it is turned on again, the missed call count during the closed period will not be displayed immediately but will be displayed together after the missed call count is increased again.
2. The data before closing Miss call will be cleared.

To configure Show Missed Calls via Web interface:

1. Click Setting→ Preference
2. Select Yes or No for Show Missed Calls.
3. Click for the setting.

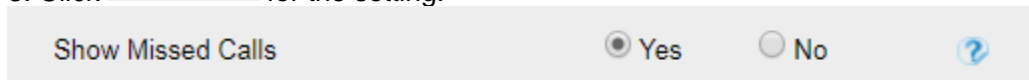

Auto Logout Time

Set the Web login timeout.

1. Login webpage, and click Setting→ Preference
2. Set number 1~5000 min for Auto Logout Time.
3. Click for the setting.

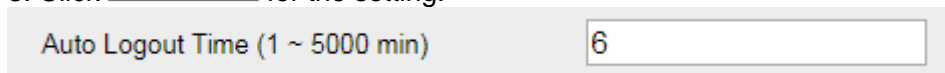

Reboot in Talking

This function is to allow reboot during the calls or not. When this function is disabled, reboot will not be executed immediately during the call, but will be executed after the call ends. When this function is enabled, reboot will be executed immediately during the call.

1. Login webpage, and click Setting→ Preference
2. Set Enable or Disable for Reboot in Talking.
3. Click for the setting.

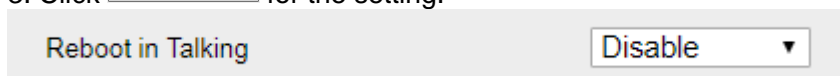

Detect IP Conflict

The IP phone will detect whether there is an IP conflict after obtaining the IP address. If so, it will prompt the IP conflict in the LCD pop-up box; you can select “Cancel” to ignore it or “Reboot” to let the phone re-request an IP address.

1. Login webpage, and click Setting→ Preference
2. Set Enable or Disable for Detect IP Conflict.
3. Click for the setting.



Redial Mode

Call redial has two ways:

- (1) To redial the last placed call from the IP Phone.
- (2) To redial the call from all calls list.

1. Login webpage, and click Setting→ Preference
2. Set Direct Mode or Select Mode for Redial Mode.
3. Click for the setting.

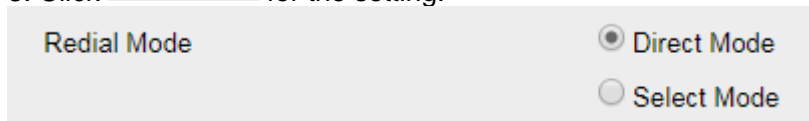

Suppress DTMF Display

Whether to hide DTMF during the call; if this function is enabled, the DTMF during the call will be displayed as *.

1. Login webpage, and click Setting→ Preference
2. Select On or Off for Suppress DTMF Display.
3. Click for the setting.

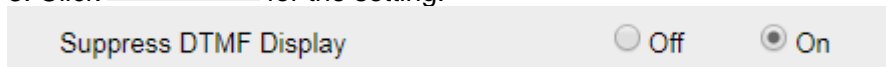

Suppress DTMF Display Delay

Whether to display briefly before hiding DTMF. The premise is suppressing DTMF Display On.

1. Login webpage, and click Setting→ Preference
2. Select On or Off for Suppress DTMF Display Delay.
3. Click for the setting.

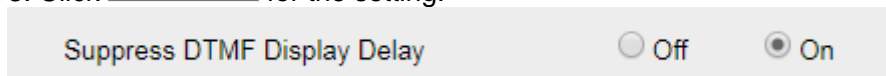

Check-Syn With Authenticate

If this option is enabled, the server needs to be authenticated before the phone agrees to synchronize.

1. Login webpage, and click Setting→ Preference
2. Set Enable or Disable for Check-Syn With Authenticate.
3. Click for the setting.

Headset Mode

How to configure Headset Priority via Phone interface:

1. Find Menu then navigate as follows: Menu->Settings->Basic Setting->Headset:
2. Enable the Headset Priority.

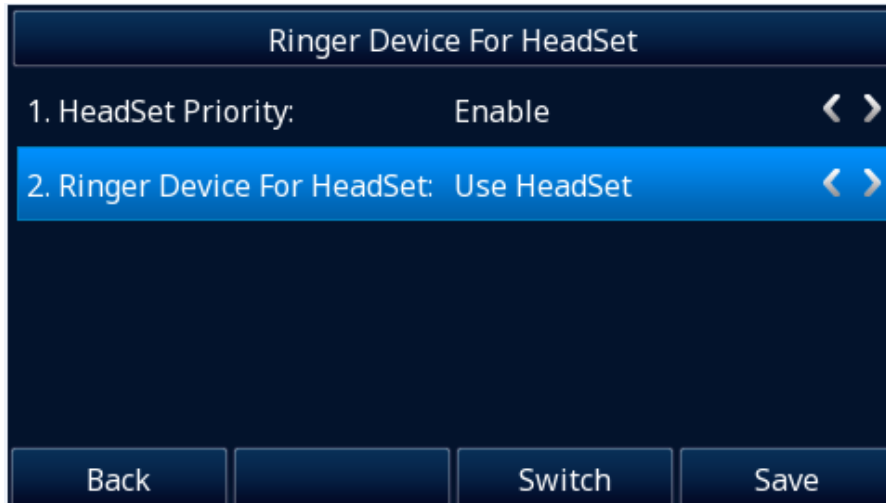

3. Choose the "Use Headset" or "Speaker&Headset" from "Ringer Device For Headset" option.
4. Press the save soft key to save the configuration.

To configure Headset Priority via web interface:

1. Login the phone's webpage (Username: admin, Password: admin)
2. Setting->Preference. Enable the Headset priority. Choose the "Use HeadSet" or "Speaker&Headset" from "Ringer Device For Headset" option.

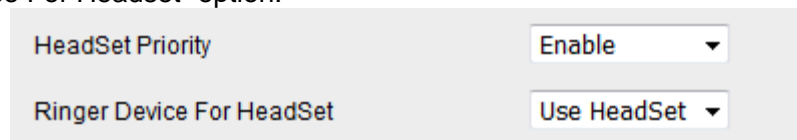

3. Click the  button to save the configuration.

To enable the headset mode:

Enable headset mode when headset priority is enabled:

1. Press the headset key on phone's during the idle status when you accomplish the above-mentioned configuration.
2. Headset icon will display on phone status bar.



Enable headset mode when headset priority is not enabled:

- Press the headset key on phone

After pressing the headset key, the phone enters the dialing mode. And the headset is used only for calling.

When dialing or calling, the headset is used as an answer mode, and the headset is not used by default as in the preceding case.

Linekey Page Reset

Linekey Page Reset means that when you establish or end a call, phone's linekey page will turn to the page which you select. And if you enable the 'Back to homepage', whatever Page for ending all calls you select, page will back to page1 when ending all calls.

To configure Linekey Page Reset via Web interface:

1. Click Setting→ Preference
2. Click on Switch pages when establishing a call/Switch pages when ending all calls
3. Select Enable/Disable
4. Click on Page for establishing a call/Page for ending all calls
5. Select Page 1/2/3/4
6. (optional)click on Back to homepage, then select No/Yes.
7. (optional)fill the Page timeout.

8. Click to save the configuration.

Page timeout	<input type="text" value="0"/>
Back to homepage	<input checked="" type="radio"/> No <input type="radio"/> Yes <input style="float: right;" type="button" value="?"/>
Switch pages when establishing a call	<input type="text" value="Disable"/>
Page for establishing a call	<input type="text" value="Page 1"/>
Switch pages when ending all calls	<input type="text" value="Disable"/>
Page for ending all calls	<input type="text" value="Page 1"/>

Gray Level

There are 20 levels. You can change the LCD's brightness according to your visual perception

Supported model: UC912 (G/E/P) UC903 UC902 (P/SP/E)

To change the gray level via Phone interface

1. Press Menu → Settings → Display → Gray level
2. Press and or press Info/Switch soft key to Choose the level from 1 to 20
3. Press or Save soft key to save the selected configuration

Network settings

Htek IP Phone supports IPv4, IPv6, IPv4&IPv6.They have two mode of Network: DHCP and Static. The default mode is DHCP, it will obtain IP address and other information automatically.

If your phone cannot contact a DHCP server for any reason, you need to configure a static IP address manually.

When switch DHCP and Static IP Address, or change the Static IP on webpage, it will show the warning of restart as following.

Network settings have been changed, Are you sure reboot the phone to save changes?

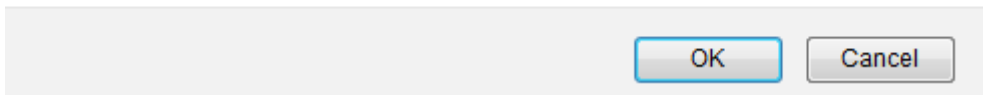

IPv4

If you set IP Mode to IPv4, IP phone will use IPv4 address. IPv4 has two network modes: DHCP and Static.

To configure IPv4 via Phone interface:

1. Press Menu→ Settings→ Advanced Setting (password: admin) → Network→ WAN Port→ IP Port Mode.

2. Press or or Switch soft key to change the IP Port Mode.
3. Press or Save soft key to save the configuration.

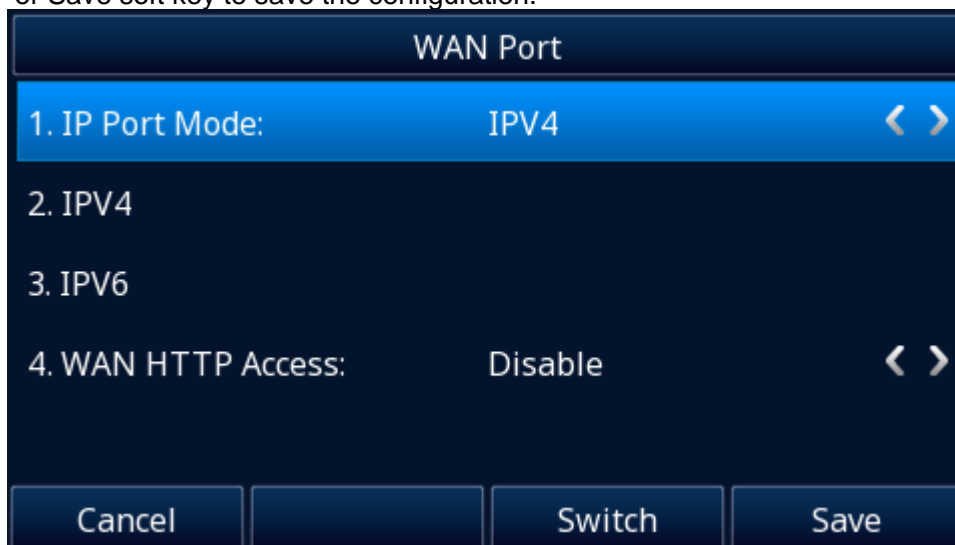

To configure IPv4 via Web interface:

1. Click Network→ Basic→ Internet Port

2. Select IPv4 for Internet Port.
3. Click for the setting.

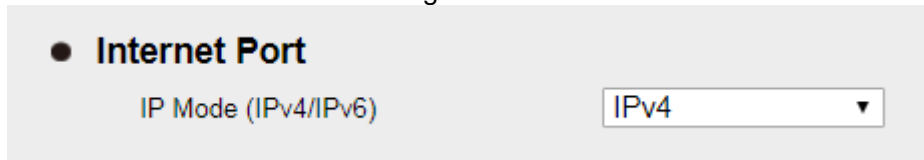

To configure DHCP via Phone interface:

1. Press Menu→ Settings→ Advanced Setting (password: admin) → Network→ WAN Port→ IPv4→ DHCP mode.
2. Click Save and the pop-up box shows "System will reboot, Are you sure?".

To configure a static IP address via Phone interface:

1. Press Menu→ Settings→ Advanced Setting (password: admin) → Network→ WAN Port→ IPv4→ Static mode.
2. Enter the parameters: IP, Netmask, Gateway, Pri.DNS (primary DNS), Sec.DNS (second DNS) in the corresponding fields.



3. Click Save and the pop-up box shows "System will reboot, Are you sure?".
4. Press the OK soft key to accept the change or the Cancel soft key to cancel.

To configure Network via Web interface:

1. Click Network→ Basic→ IPv4 Setting
2. Select the desired Type: DHCP or Static IP Address.
3. Fill in the necessary information.
4. Click and the pop-up box shows "System will reboot, Are you sure?".

● IPv4 Setting

DHCP ?

DHCP HostName

DHCP Domain

DHCP Vendor Class Id

DHCP User Class

Static IP Address ?

IP Address . . .

Subnet Mask . . .

Default Gateway . . .

Static DNS No Yes



Primary DNS . . .

Secondary DNS . . .

IPv6

If you set IP Mode to IPv6, IP phone will use IPv6 address. IPv6 has two network modes: DHCP, Static IP Address.

To configure IPv6 via Phone interface:

1. Press Menu → Settings → Advanced Setting (password: admin) → Network → WAN Port → IP Port Mode.
2. Press  or  to change the IP Port Mode.
3. Press  or Save soft key to save the configuration.

WAN Port

1. IP Port Mode: IPV6 < >

2. IPV4

3. IPV6

4. WAN HTTP Access: Disable < >

Cancel
Switch
Save

To configure IPv6 via Web interface:

1. Click Network → Basic → Internet Port
2. Select IPv6 for Internet Port.

3. Click for the setting.

● Internet Port

IP Mode (IPv4/IPv6)

To configure DHCP via Phone interface:

1. Press Menu→ Settings→ Advanced Setting (password: admin)→ Network→ WAN Port→ IPv6→ DHCP mode.
2. Click Save and the pop-up box shows "System will reboot, Are you sure?".

To configure a static IP address via Phone interface:

1. Press Menu→ Settings→ Advanced Setting (password: admin) → Network→ WAN Port→ IPv6→ Static mode.
2. Enter the parameters: IP, IPV6 Prefix, Gateway, Pri.DNS (primary DNS), sec.DNS (second DNS) in the corresponding fields.

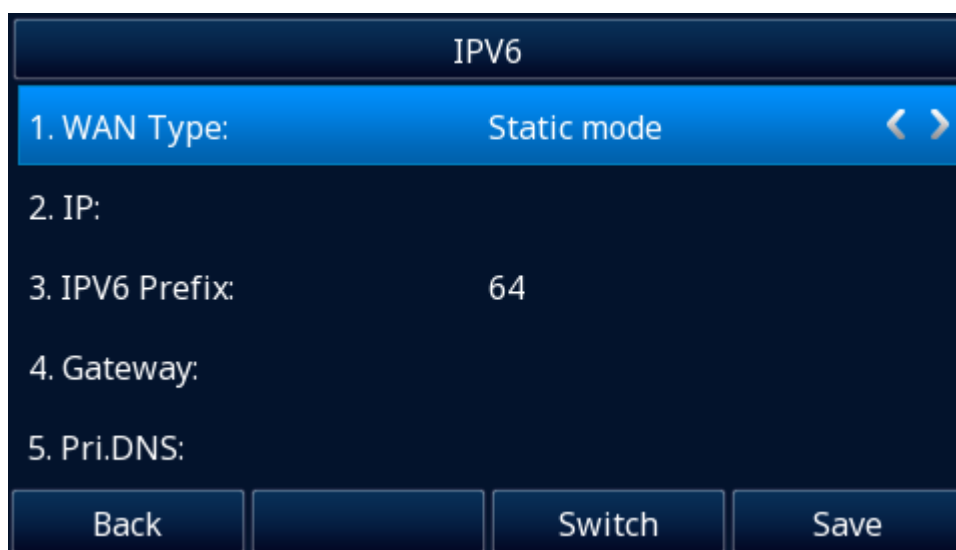

3. Click Save and the pop-up box shows "System will reboot, Are you sure?".

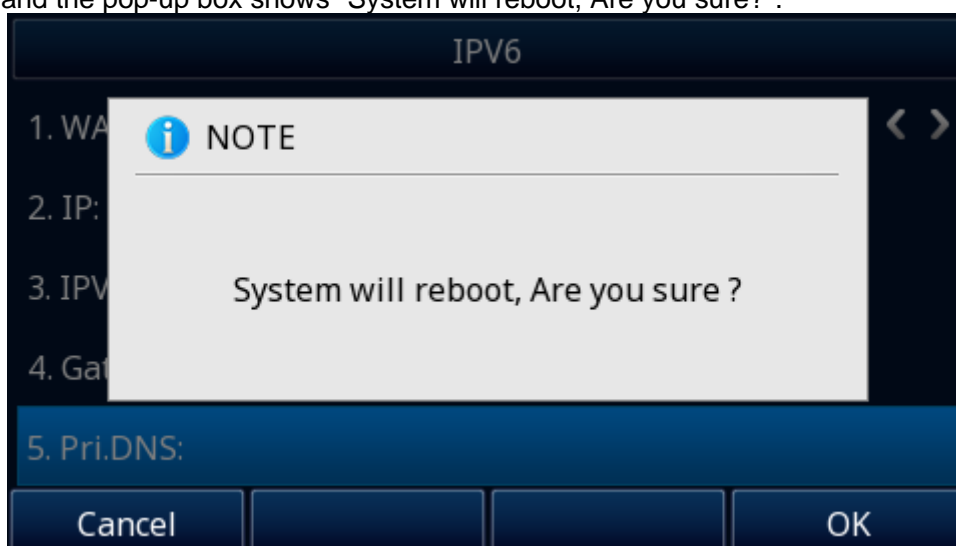

To configure Network via Web interface:

1. Click Network→ Basic→ IPv6 Setting
2. Select the desired Type: DHCP, Static IP Address.
3. Fill in the required fields.
4. Click and the pop-up box shows "System will reboot, Are you sure?".

● **IPv6 Setting**

DHCP ?

Static IP Address ?

IP Address

IPv6 Prefix (0~128)

Default Gateway

IPv6 Static DNS No Yes



Primary DNS

Secondary DNS

IPv4&IPv6

If you set IP Mode to IPv4&IPv6, IP phone will support both IPv4 and IPv6 address. The settings of DHCP and Static IP Address are same as above.

To configure IPv4&IPv6 via Phone interface:

1. Press Menu → Settings → Advanced Setting (password: admin) → Network → WAN Port → IP Port Mode.
2. Press  or  to change the IP Port Mode.
3. Press  or Save soft key to save the configuration.

WAN Port

1. IP Port Mode: IPV4&IPV6 < >

2. IPV4

3. IPV6

4. WAN HTTP Access: Disable < >

Cancel
Switch
Save

To configure IPv4&IPv6 via Web interface:

1. Click Network → Basic → Internet Port
2. Select IPv4&IPv6 for Internet Port.
3. Click for the setting.

● Internet Port

IP Mode (IPv4/IPv6)	IPv4&IPv6
Preference(IPv4/IPv6)	IPv6

Note:

Wrong network parameters may result in inaccessibility of your phone and may also have an impact on your network performance. For more information about these parameters, contact your system administrator.

Preference (IPv4/IPv6)

When the network set as IPv4&IPv6 dual stack mode, you can set the parameter “Preference (IPv4/IPv6)” to choose which IP protocol will be used in the higher priority.

Note: This function will only be displayed in IPv4&IPv6 dual stack, that is, when IP Mode (IPv4/IPv6): IPv4&IPv6, the Preference function will be displayed.

To configure Preference via Web interface:

1. Click Network→ Basic→ Internet Port → Preference (IPv4/IPv6)
2. Select IPv4 or IPv6 as you prefer.
3. Click for the setting.

● Internet Port	
IP Mode (IPv4/IPv6)	IPv4&IPv6
Preference(IPv4/IPv6)	IPv4

4. If change the Preference on webpage, a warning window will pop up, "Network settings have been changed, are you sure reboot the phone to save changes?" Click OK, the phone will restart.

Network settings have been changed, Are you sure reboot the phone to save changes?

<input type="button" value="OK"/>	<input type="button" value="Cancel"/>
-----------------------------------	---------------------------------------

PC Port

Two modes for PC Port: bridge and Connect to Expansion Module.

To Select the PC Port via Phone interface:

1. Press Menu→ Settings→ Advanced Setting (password: admin) → Network→ PC Port→ Bridge mode/Expansion Module.
2. Click Save and the pop-up box shows "System will reboot, Are you sure?".
3. Click the OK button, then the phone will reboot.

To Select the PC Port via Web interface:

1. Click Network→ PC Port
2. Select As Bridge/Connect to Expansion Module.
3. Click and then click , the phone will reboot automatically.

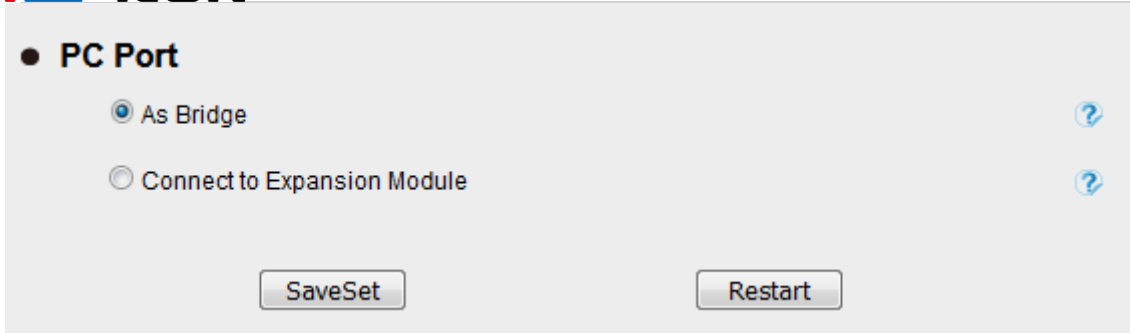

Note: The As Bridge mode is selected by default, and the “Connect to Expansion Module” mode is only required when the phone is connected to the expansion module.

System settings

Factory Reset

To set Factory Reset via Phone interface

1. Press Menu→ Settings→ Advanced Setting (default password: **admin**)→ Phone Setting→ Factory Reset
2. Press OK soft key in the warning page.

To set Factory Reset via Web interface

1. Click Management→ Upgrade
2. Click and then confirm the setting.

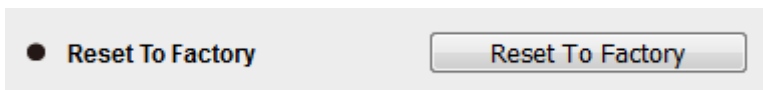

Pcap Feature

To use Pcap feature via Web interface:

1. Click Management→ Tools
2. Click and then operation the phone
3. When finishing the operation, click and then click .
4. Then you'll get the Pcap captures.

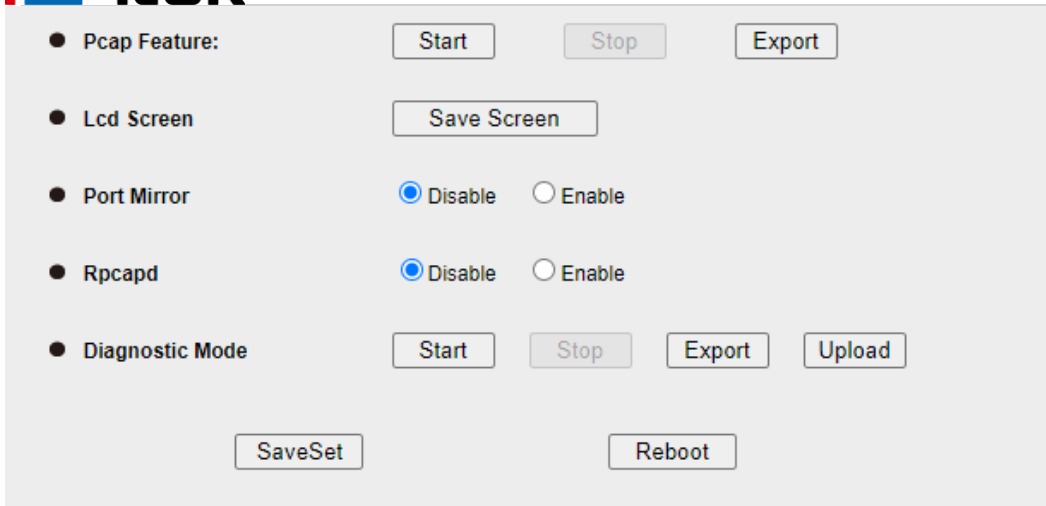

● Pcap Feature:

● Lcd Screen

● Port Mirror Disable Enable

● Rpcapd Disable Enable

● Diagnostic Mode

System Log

To download system log via Web interface:

1. Click Management → Configuration
2. Select the Syslog Level

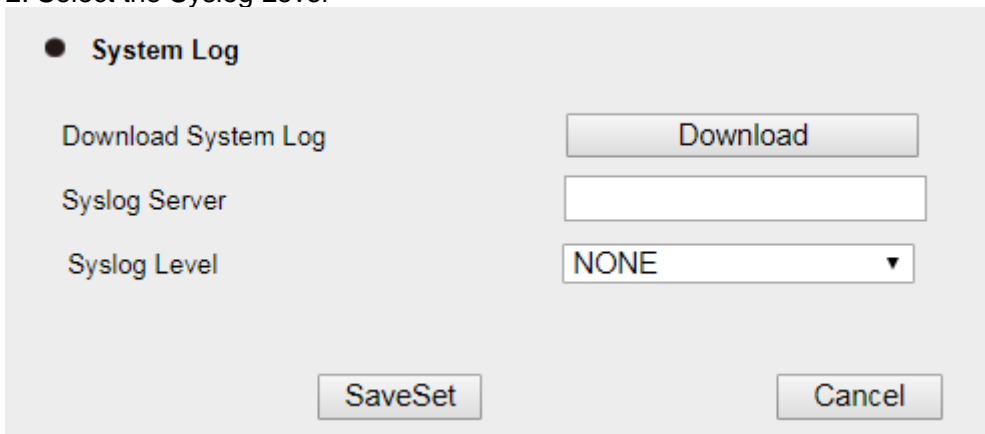

● System Log

Download System Log

Syslog Server

Syslog Level

3. Click of the System Log.
4. Then you will get a txt file: syslog.txt.

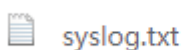

Upgrade

To upgrade via HTTP, the “Management” → “Auto Provision” → “Firmware Upgrade” → “Upgrade Mode” field needs to be set to HTTP, respectively. “Firmware Server Path” needs to be set to a valid URL of a HTTP server, server name can be in either FQDN or IP address format. Here are examples of some valid URL.

- e.g. firmware.mycompany.com:5688
- e.g. www.mycompany.com:5688/fm
- e.g. 218.2.83.110

Instructions for firmware upgrade via HTTP:

- (1) End users can choose to download the free HTTP server from <http://httpd.apache.org/> or use Microsoft IIS web server. Then setup HTTP server.
- (2) Unzip the firmware file and put all of them under the *root/fm* directory of the HTTP server.
- (3) Visit “http://192.168.0.254/fm/fw920D.rom” on localhost by browser to verify the HTTP Server. If visiting “http://192.168.0.254/fm/fw920D.rom” on another computer and it is not prompted to download fw920D.rom file on this computer, please check if the firewall is on or off (Suggest you turn off the

firewall).

To configure the server path via Web interface:

1. Click Management→ Auto Provision
2. Select the upgrade mode in the Upgrade Mode field
3. Enter the Firmware Server Path and Config Server Path (192.168.0.254 is HTTP server).
4. Enter the HTTP server's username and password (optional).
5. Click the **SaveSet** button to save the configuration.
6. Restart the UC926U, IP Phone will restart and auto-get firmware files from HTTP server.

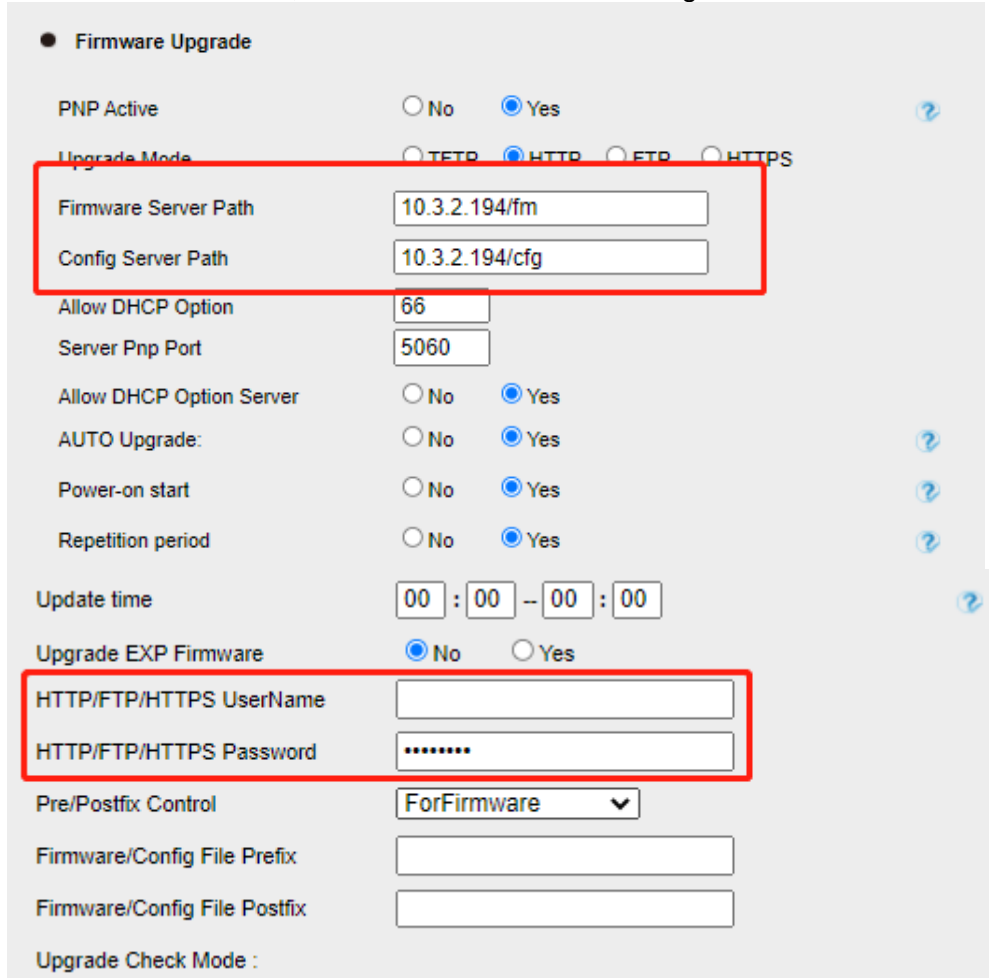

Firmware Upgrade

PNP Active No Yes

Upgrade Mode TFTP HTTP FTP HTTPS

Firmware Server Path

Config Server Path

Allow DHCP Option

Server Pnp Port

Allow DHCP Option Server No Yes

AUTO Upgrade: No Yes

Power-on start No Yes

Repetition period No Yes

Update time : -- :

Upgrade EXP Firmware No Yes

HTTP/FTP/HTTPS UserName

HTTP/FTP/HTTPS Password

Pre/Postfix Control

Firmware/Config File Prefix

Firmware/Config File Postfix

Upgrade Check Mode :

NOTES:

- Htek recommends end-user use the Htek HTTP server. For large companies, we recommend maintaining their own TFTP/HTTP/FTP/HTTPS server for upgrade and provisioning procedures.
- Once a "Firmware Server Path" is set, user needs to update the settings and restart the IP Phone. If the configured firmware server is found and a new code image is available, the UC926U will attempt to retrieve the new image files by downloading them into the UC926U's SDRAM. During this stage, the UC926U's LEDs will blink fast until the checking/downloading process is completed. Upon verification of checksum, the new code image will then be saved into the Flash. If TFTP/HTTP/FTP/HTTPS fails for any reason (e.g. TFTP/HTTP/FTP/HTTPS server is not responding, there are no code image files available for upgrade, or checksum test fails, etc), the UC926U will stop the TFTP/HTTP/FTP/HTTPS process and simply boot using the existing code image in the flash.
- Firmware upgrade may take as long as 3 to 8 minutes over Internet, or just 1 minutes if it is performed on a LAN. It is recommended to conduct firmware upgrade in a controlled LAN environment if possible. For users who do not have a local firmware upgrade server.
- Htek's latest firmware is available at www.htek.com→ Support→ Document & Firmware.
- Oversea users are strongly recommended to download the binary files and upgrade firmware locally in a controlled LAN environment.

To upgrade manually via the Web configuration interface

1. Click Management→ Upgrade

2. Click or the blank.

3. Select the firmware (fw920D.rom) and then click .

ROM Firmware Upgrade

Please choose the upgrade file: **fw920D.rom**

Configuration File

To download configuration file

1. Click Management→ Configuration→ Configure File

2. Click the or , then you can get a file: cfg.xml or cfg.bin.

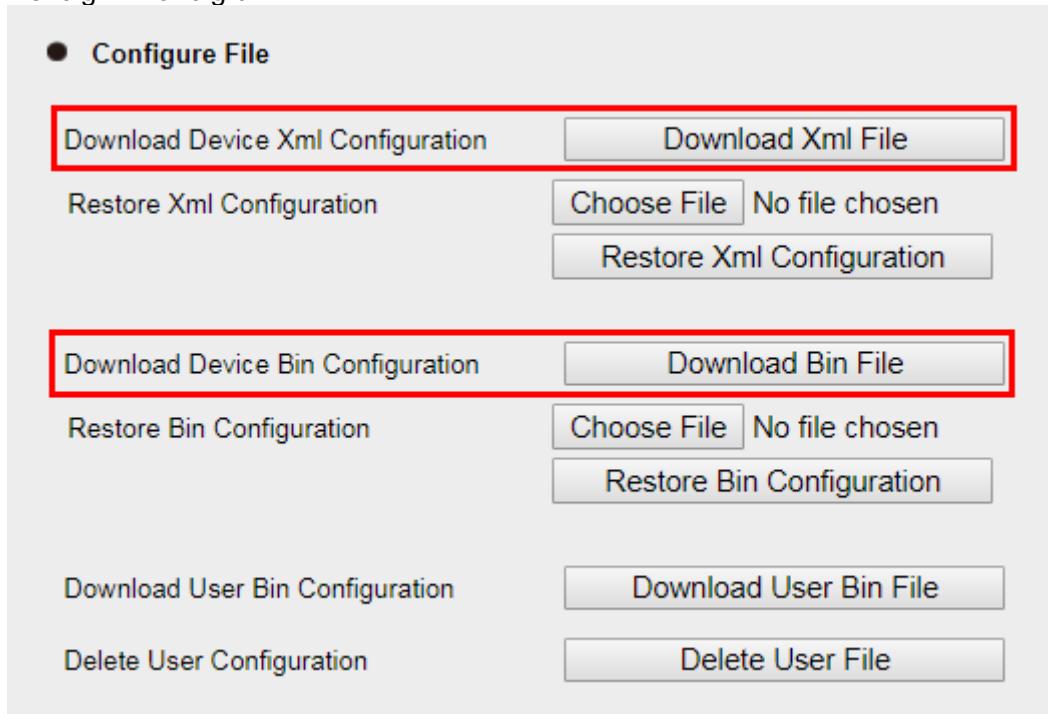

● **Configure File**

Download Device Xml Configuration	<input type="button" value="Download Xml File"/>
Restore Xml Configuration	<input type="button" value="Choose File"/> No file chosen <input type="button" value="Restore Xml Configuration"/>
Download Device Bin Configuration	<input type="button" value="Download Bin File"/>
Restore Bin Configuration	<input type="button" value="Choose File"/> No file chosen <input type="button" value="Restore Bin Configuration"/>
Download User Bin Configuration	<input type="button" value="Download User Bin File"/>
Delete User Configuration	<input type="button" value="Delete User File"/>

To restore a configuration file

1. Click Management→ Configuration→ Configure File

2. Select the xxx.xml or xxx.bin file, and then Click the or , then IP Phone will reboot.

● **Configure File**

Download Device Xml Configuration	Download Xml File
Restore Xml Configuration	Choose File No file chosen
	Restore Xml Configuration
Download Device Bin Configuration	Download Bin File
Restore Bin Configuration	Choose File No file chosen
	Restore Bin Configuration
Download User Bin Configuration	Download User Bin File
Delete User Configuration	Delete User File

Optional Accessories with Your Phone

Headsets

The phone supports wired headset and Bluetooth headset to place and answer calls. You can use only one headset at a time.

Note: Bluetooth headset is only supported by UC926U.

Bluetooth Headset

You can use a Bluetooth headset to handle calls on the phones. For more information, refer to the documentation from your Bluetooth headset manufacturer.

Using Headsets

After connecting a headset to your phone, you can activate the headset mode and use the headset when answering and placing calls. If you do not want to use a headset to handle calls, you can deactivate the headset mode.

To use the headsets:

1. Press the HEADSET key  on the phone.
2. The headset icon appears on the phone screen.



3. Press the HEADSET key  again on the phone. The headset icon disappears from the phone screen.

Expansion module

The expansion module is a console you can use to connect to a phone to add additional Ext keys and expand the functions of your phone.

For more information about the expansion module UC46, please contact technical support, refer to the Htek expansion module UC46 user guide.

Note: Expansion module is only supported by UC926(U/E/S) and UC924(U/E/W).

Connecting the Expansion Module

How to connect expansion modules?

1. You can connect the expansion module to your phone, using the supplied materials in the expansion module's packaging.
2. Click to Network->PC port.
3. Select to the Connect to Expansion Module.

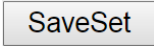
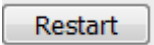

4. Click the  button to save the configuration.
5. Click the  button to restart the IP Phone.

6. The phone will restart. After restarting, you can see that the phone is connected to the expansion module, as shown in the figure below, showing the relevant version information.

Version

Product Model UC926

Firmware Version
 BOOT--2.20.11.3(2020-11-03 00:11:00)
 IMG--2.20.11.3.16(2020-11-03 00:11:00)
 ROOTFS--2.20.11.3(2020-11-03 00:11:00)
 ROM--2.20.11.3.16(2020-11-03 00:11:00)
 DSP--9.0.3(Patch 1.0.16D)

Expansion Module Version

Expansion Module 1
 BOOT--2.0.4.5(2018-03-22 16:55:00)
 IMG--2.0.5.48(2019-12-31 14:23:00)
 ROM--2.0.5.48(2019-12-31 14:23:00)

Restart Reboot

Version on phone ROM-(N/A)
 Delete All

USB Button

Htek IP phones support USB Button that connects to the USB port of the IP phones to implement various configuration functions. USB Button can be used in normal mode and emergency mode, with different usage scenarios.

1. Plug the Panic Button into the USB port on the back (or side) of the IP phone.
2. Login: Input the IP address in the web browser. (Login name: admin; default password: admin).
3. Click **Function keys** ->**USB KEY**
4. Choose **USB key mode**: Emergency or Normal
5. Choose **Type** and fill in the **Value** (optional)
6. Click the button to save the configuration.

IP PHONE Home | Profile | Account | Network | **Function Keys** | Settings

Line Key
 Programmable Key
 EXP KEY
 USB KEY

USB key mode Emergency mc

USB	Type	Value	Label	Account	Extension
Key	Silent Call	4004	4004	Account 1	

SaveSet Reboot

Troubleshooting

Why is the phone LCD screen blank?

- Ensure your phone is properly plugged into a functional AC outlet.
- Ensure that the phone is not plugged into a plug controlled by a switch that is off.
- If the phone is plugged into a power strip, try plugging it directly into a wall outlet instead.
- If your phone is powered from PoE, ensure you use a PoE compliant switch or hub, or contact your system administrator for more information.
- Check if the power LED is on to ensure that the phone is powered on.

Why does the phone display “Network Unavailable”?

To resolve:

- Ensure that the Ethernet cable is plugged into the Internet port on the phone and the Ethernet cable is not loose.
- Ensure that the switch or hub in your network is functioning well.
- If the problem persists, Contact your system administrator for more information.

Why can't I get a dial tone?

To resolve:

- Check for any loose connections and that the phone has been installed properly. For the Installation instructions, refer to the [Phone Installation](#) section.
- Check whether dial tone is present on one of the audio modes.
- Switch between the Handset, Headset (if you have) or Hands-Free Speakerphone to check whether dial tone is present for one of the audio modes.
- If the dial tone exists on another audio mode, connect a different handset or headset to isolate the problem.

Where to set the tone?

You can set the tone on web interface:

- Click Setting→ Tones
- Define the Dial Tone, Ringback Tone, Busy Tone...
- For the tones, you can check with your system administrator.
- For More Click [Configure Ring Tones](#).

Select Country	Custom ▾
Dial Tone	f1=350@-13,f2=440@-13,c=0/0;
Ringback Tone	f1=440@-19,f2=480@-19,c=2000/4000;
Busy Tone	f1=480@-24,f2=620@-24,c=500/500;
Reorder Tone	f1=480@-24,f2=620@-24,c=250/250;
Confirmation Tone	f1=350@-11,f2=440@-11,c=100/100-100/100-100/100;
Call Waiting Tone	f1=440@-13,c=300/10000-300/10000-0/0;

Syntax: f1=freq@vol, f2=freq@vol, c=on1/off1-on2/off2-on3/off3; [...]
Note: freq: 0 - 4000Hz; vol: -30 - 0dBm

How to download XML Configuration?

- Click Management → Configuration →

How to Import Trusted CA certificate?

- Click Management → Trusted CA

Index	Issued TO	Issued By	Expiration	Delete
1				<input type="checkbox"/>
2				<input type="checkbox"/>
3				<input type="checkbox"/>
4				<input type="checkbox"/>
5				<input type="checkbox"/>
6				<input type="checkbox"/>
7				<input type="checkbox"/>
8				<input type="checkbox"/>
9				<input type="checkbox"/>
10				<input type="checkbox"/>

Import Trusted Certificate Files No file chosen

Only Accept Trusted Certificates On Off

Common Name Validation On Off

Trusted Certificates Default Certificates
 Custom Certificates
 All Certificates

How to Import Server CA certificate?

- Click Management → Server CA

Issued TO	Issued By	Expiration	Delete
			Delete
Import Server Certificate Files	Choose File	No file chosen	
	Import Server Certificates		
Device Certificates	<input checked="" type="radio"/> Default Certificates		
	<input type="radio"/> Custom Certificates		
	SaveSet	Cancel	

How to use Vlan?

- For Vlan information, please click [VLAN](#)

How to use LLDP?

- For LLDP information, please click [VLAN](#)
- VLAN Notes including:
 1. Voice VLAN
 2. Major Benefits of Using VLANs
 3. VLAN discovery method on Htek IP Phones
 4. LLDP Feature on Htek IP Phones
 5. Supported TLVS of IP Phones
 6. Configuring LLDP Feature
 7. DHCP VLAN
 8. Open the DHCP VLAN on the Htek IP Phones
 9. VLAN under Bridge Mode
 10. VLAN under NAT Mode

How to Set LCD and Web GUI?

- Click [UC900 Series IP Phones Provisioning](#).

How to Upgrade via FTP?

- Click [Upgrading Firmware of IP Phones](#).

How to make Ringtone?

- Click [Make Ring Tones](#).

How to use Open VPN?

- Click [Open VPN Guide](#).

Provisioning Guide on Free PBX

- Click [FreePBX Configuring Guide](#).

Redundancy Server

- Click [Redundancy Server](#).

How to Use Auto Provision Phonebook?

- Click [AP Phonebook](#).

All Documents

- Click [Documents Guide](#), you can get all tech files.